

2012 DOE HYDROGEN and FUEL CELLS PROGRAM and VEHICLE TECHNOLOGIES PROGRAM ANNUAL MERIT REVIEW and PEER EVALUATION MEETING OVERALL SCHEDULE

Monday May 14 - Gateway Hotel
1:00 Guest Speakers and Overviews of the Hydrogen and Fuel Cells Program and Vehicle Technologies Program (Salons III and IV)
3:00 Break
3:30 Hydrogen Sub-Program Overviews (Salon III) and Vehicle Technologies Program Sub-Program Overviews (Salon IV)
5:30 Break
5:45 Reviewer Orientation Salon II
6:00 Poster Session I: Electrochemical Storage and Vehicle and System Simulation

Schedule as of: 10-May-12

Crystal Gateway Marriott Hotel

Salon	Tuesday May 15							Wednesday May 16							Thursday May 17						Friday May 18							
	I	II	III	IV	V	VI	Alex.*	I	II	III	IV	V	VI	Alex.*	I	II	III	IV	V	VI	I	II	III	IV	V	VI		
7:15 AM	Continental Breakfast																											
8:15 AM	APE	AN	ES	FC	ST	VSS	PM	APE	PD	ES	FC	ST	VSS	LM	LM	PD	ES	FC	ST	VSS	LM			FC		VSS		
8:30 AM	APE	AN	ES	FC	ST	VSS	PM	APE	PD	ES	FC	ST	VSS	LM	LM	PD	ES	FC	ST	VSS	LM			FC		VSS		
9:00 AM	APE	AN	ES	FC	ST	VSS	PM	APE	PD	ES	FC	ST	VSS	LM	LM	PD	ES	FC	ST	VSS	LM			FC		VSS		
9:30 AM	APE	AN	ES	FC	ST	VSS	PM	APE	PD	ES	FC	ST	VSS	LM	LM	PD	ES	FC	ST	VSS	LM			FC		VSS		
10:00 AM	APE	AN	ES	FC	ST	VSS	PM	APE	PD	ES	FC	ST	VSS	LM	LM	PD	ES	FC	ST	VSS	LM			FC		VSS		
10:30 AM	Break																											
11:00 AM	APE	AN	ES	FC	ST	VSS	PM	APE	PD	ES	FC	ST	VSS	LM	LM	PD	ES	FC	ST	VSS	LM			FC		VSS		
11:30 AM	APE	AN	ES	FC	ST	VSS	PM	APE	PD	ES	FC	ST	VSS	LM	LM	PD	ES	FC	ST	VSS	LM			FC		VSS		
12:00 PM	APE	AN	ES	FC	ST	VSS	PM	APE	PD	ES	FC	ST	VSS	LM	LM	PD	ES	FC	ST	VSS	LM			FC		VSS		
12:30 PM	Lunch																											
1:00 PM	1:00 PM - N. Whitcombe, Advanced Technology Vehicles Manufacturing Incentive Program																											
1:15 PM	1:15 PM - Pat Davis, Vehicle Technologies Program Awards																											
1:45 PM	APE	AN	ES	FC	ST	VSS	PM	MN	PD	ES	FC	ST	VSS	LM	LM	PD	ES	FC	ST	VSS	LM			FC		VSS		
2:00 PM	APE	AN	ES	FC	ST	VSS	PM	MN	PD	ES	FC	ST	VSS	LM	LM	PD	ES	FC	ST	VSS	LM			FC		VSS		
2:15 PM	APE	AN	ES	FC	ST	VSS	PM	MN	PD	ES	FC	ST	VSS	LM	LM	PD	ES	FC	ST	VSS	LM			FC		VSS		
2:45 PM	APE	AN	ES	FC	ST	VSS	PM	MN	PD	ES	FC	ST	VSS	LM	LM	PD	ES	FC	ST	VSS	LM			FC		VSS		
3:15 PM	APE	AN	ES	FC	ST	VSS	PM	MN	PD	ES	FC	ST	VSS	LM	LM	PD	ES	FC	ST	VSS	LM			FC		VSS		
3:45 PM	Break																											
4:15 PM	APE	AN	ES	FC	ST	VSS	PM	MN	PD	ES	FC	ST	VSS	LM	LM	PD	ES	FC		VSS	LM			FC		VSS		
4:45 PM	APE		ES	FC	ST	VSS	PM	MN	PD	ES	FC	ST	VSS	LM	LM	PD	ES	FC		VSS	LM			FC		VSS		
5:15 PM	APE		ES		ST	VSS	PM		PD	ES	FC	ST	VSS	LM	LM		ES	FC		VSS	LM			FC		VSS		
5:45 PM			ES			VSS	PM		PD	ES		ST	VSS	LM			ES			VSS						VSS		

*Alexandria - second floor

*Alexandria - second floor

H₂ & FC Program	PD: Production & Delivery
	ST: Hydrogen Storage
	FC: Fuel Cells
	MN: Manufacturing
	TV: Technology Validation
	SCS: Safety, Codes, Stand.
	ED: Education
	MT: Market Transformation
	AN: Analysis
	H2RA: Recovery Act
VT Program	AC: Advanced Combustion
	ES: Energy Storage
	APE: Adv. Pwr. Electronics
	FT: Fuels Technologies
	PM: Propulsion Materials
	TI: Technology Integration
VSS: Veh. & Sys. Simulation	

6:30 PM **POSTER SESSION II:** Electrochemical Storage, Advanced Power Electronics, Technology Integration, Fuel Cells, and Hydrogen Production and Delivery

6:30 PM **POSTER SESSION III:** Electrochemical Storage, Hydrogen Storage, Basic Energy Sciences (hydrogen storage), Hydrogen Production and Delivery, and H2 Recovery Act

6:30 PM **POSTER SESSION IV:** Technology Validation, Advanced Combustion, and Solid State Energy Conversion

6:30 PM **AC: Advanced Combustion**
ES: Energy Storage
APE: Adv. Pwr. Electronics
FT: Fuels Technologies
PM: Propulsion Materials
LM: Light-Weight Materials
TI: Technology Integration
VSS: Veh. & Sys. Simulation

Crystal City Marriott Hotel

Salon	Tuesday May 15			Wednesday May 16			Thursday May 17			Friday May 18		
	D	E	F	D	E	F	D	E	F	D	E	F
7:15 AM	Continental Breakfast											
8:15 AM	FT	AC	SCS									
8:30 AM	FT	AC	SCS	TI	AC	MT	TI	AC	ED	TI	AC	AC
9:00 AM	FT	AC	SCS	TI	AC	MT	TI	AC	ED	TI	AC	AC
9:30 AM	FT	AC	SCS	TI	AC	MT	TI	AC	ED	TI	AC	AC
10:00 AM	FT	AC	SCS	TI	AC	MT	TI	AC	ED		AC	AC
10:30 AM	Break											
11:00 AM	FT	AC	SCS	TI	AC		TI	AC	ED		AC	AC
11:30 AM	FT	AC	SCS	TI	AC		TI	AC			AC	AC
12:00 PM	FT	AC	SCS		AC		TI	AC			AC	AC
12:30 PM	Lunch*											
1:30 PM				AC	H2RA				TV			
1:45 PM	FT	AC	SCS	TI	AC	H2RA	TI	AC	TV			
2:15 PM	TI	AC	SCS	TI	AC	H2RA	TI	AC	TV			
2:45 PM	TI	AC	SCS	TI	AC	H2RA	TI	AC	TV			
3:15 PM	TI	AC	SCS	TI	AC	H2RA	TI		TV			
3:45 PM	Break											
4:00 PM												
4:15 PM	TI	AC		TI	AC	H2RA	TI	AC	TV			
4:45 PM	TI	AC		TI	AC	H2RA	TI	AC				
5:15 PM	TI	AC		TI	AC	H2RA	TI	AC				
5:45 PM	TI	AC		TI	AC	H2RA		AC				

Save the date: the 2013 AMR will be May 13-17



*Awards Ceremonies and Speakers will be in the Crystal Gateway hotel



Mezzanine Level

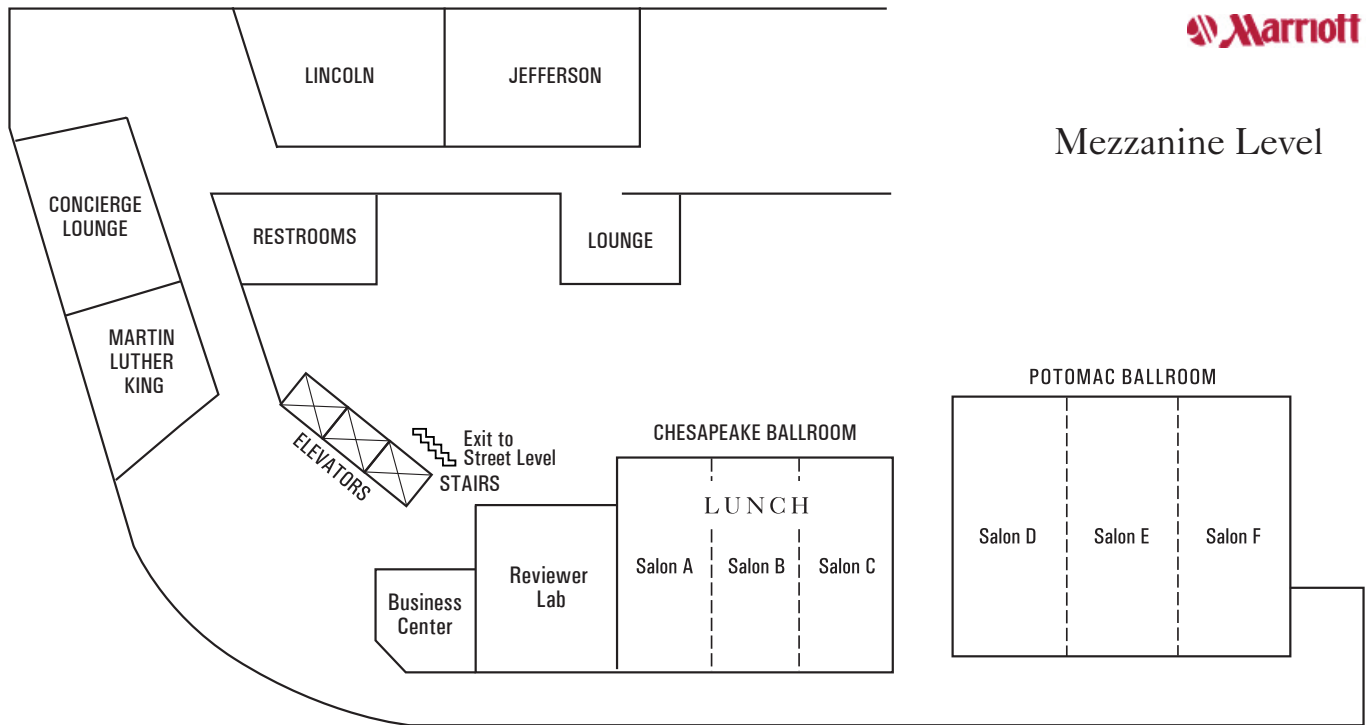

Crystal City Marriott



FIRST FLOOR

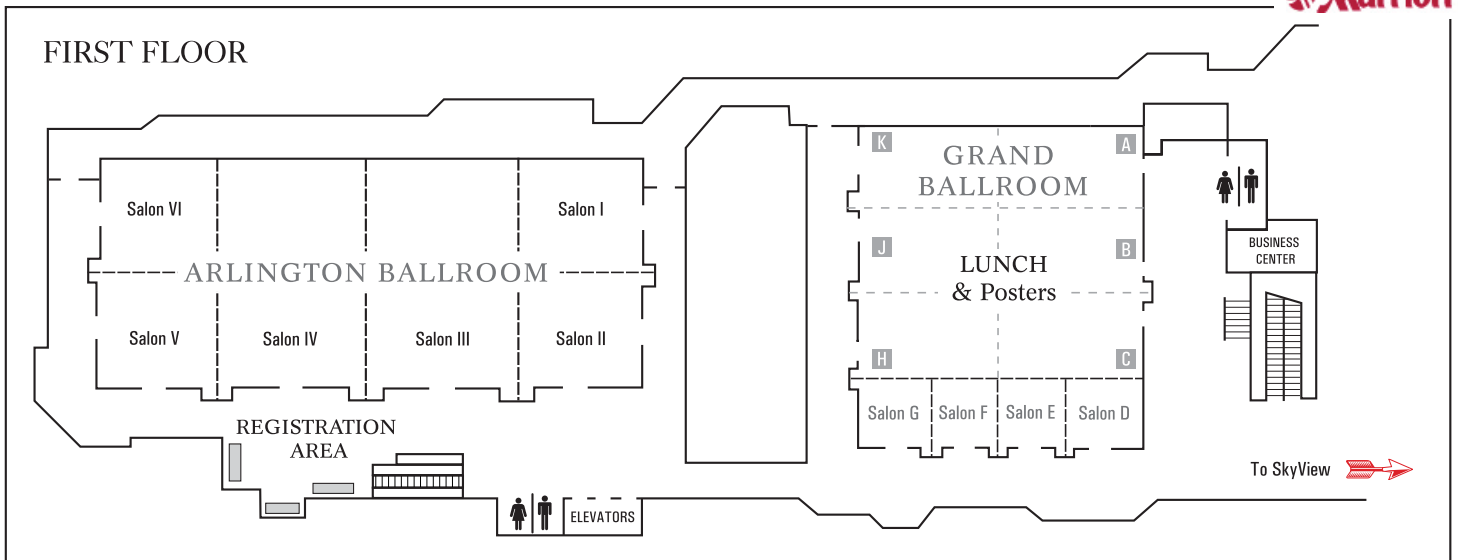

SECOND FLOOR Meeting Rooms

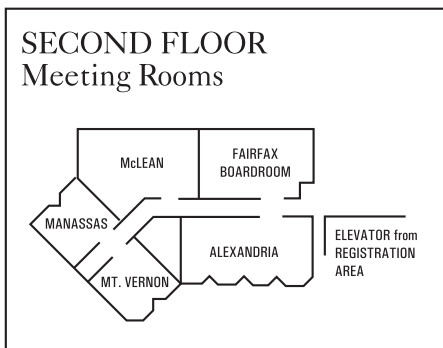

LOBBY LEVEL Meeting Rooms and Reviewer Lab

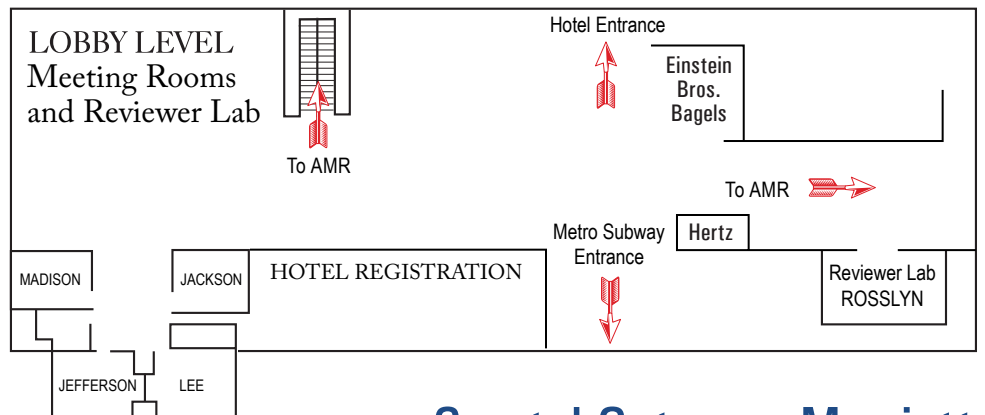

Crystal Gateway Marriott



Monday, May 14 - Poster Presentations

Crystal Gateway Hotel - Grand Ballroom, 6:00-8:00 PM

Electrochemical Storage
ES125; Donghai Wang, Pennsylvania State University: Development of High Energy Density Lithium-Sulfur Cells
ES126; Ionel Stefan, Amprius: Silicon Nanostructure-based Technology for Next Generation Energy Storage
ES127; Dr. J Kim, Dow Kokam: Development of Large Format Lithium Ion Cells with Higher Energy Density Exceeding 500Wh/L
ES128; Sergey Lopatin, Applied Materials: Modular Process Equipment for Low Cost Manufacturing of High Capacity Prismatic Li-Ion Cell Alloy Anodes
ES129; Hany Eitouni, Seoo: High-Voltage Solid Polymer Batteries for Electric Drive Vehicles
ES130; Yimin Zhu, Nanosys: Innovative Cell Materials and Designs for 300 Mile Range EVs
ES131; Jehwon Choi, 3M Company: High Energy Novel Cathode / Alloy Automotive Cell
ES132; Gary Voelker, Miltec UV International: Utilization of UV or EB Curing Technology to Significantly Reduce Costs and VOCs in the Manufacture of Lithium-Ion
ES133; Bernhard Metz, Johnson Controls: Significant Cost Improvement of Li-Ion Cells Through Non-NMP Electrode Coating, Direct Separator Coating, and Fast
ES134; Mike Wixom, A123 Systems: Dry Process Electrode Fabrication
ES135; Brad Brodie, DENSO International America: Stand-Alone Battery Thermal Management System
ES136; Steve Carlson, Optodot Corporation: Innovative Manufacturing and Materials for Low-Cost Lithium-Ion Batteries
ES049; Michael Thackeray, ANL : Design and Evaluation of Novel High Capacity Cathode Materials
ES051; Arumugam Manthiram, U of Texas at Austin : HIGH-VOLTAGE SPINEL AND POLYANION CATHODES
ES095; Ray Unocic, ORNL: In-Situ Electron Microscopy of Electrical Energy Storage Materials
ES106; Jagjit Nanda, ORNL: Studies on High Voltage Lithium Rich MNC Composite Cathodes
ES143; Jack Vaughey, ANL: Three Dimensional Anodes and Architectures
ES063; Stanley Whittingham, Binghamton University-SUNY: Metal-Based, High-Capacity Lithium-Ion Anodes
ES061; Prashant Kumta, University of Pittsburgh: Nanoscale Heterostructures and Thermoplastic Resin Binders: Novel Lithium-Ion Anodes
ES144; Ji-Guang (Jason) Zhang, PNNL: Development of Si-based High Capacity Anodes
ES145; Anne Dillon, NREL: Atomic Layer Deposition for Stabilization of Amorphous Silicon Anodes
ES146; Michael Naquib, Drexel University: New Layered Nanolaminates for Use in Lithium Battery Anodes
ES147; Donghai Wang, Pennsylvania State University: Synthesis and Characterization of Structured Si-Carbon Nanocomposite Anodes and Functional Polymer
ES148; Yi Cui, Stanford University: Designing Silicon Nanostructures for High Energy Lithium Ion Battery Anodes
ES149; Kwai Chan, SwRI: Synthesis and Characterization of Silicon Clathrates for Anode Applications in Lithium-Ion Batteries
ES040; Esther Takeuchi, U at Buffalo: Bimetallic Electrochemical Displacement Materials Yielding High Energy, High Power, and Improved Reversibility
ES042; Chengdu Liang, ORNL: In situ Studies of Solid Electrolyte Interphase on Nanostructured Materials
ES043; Wesley Henderson, North Carolina State U: Linking Ion Solvation and Lithium Battery Electrolyte Properties
ES160; Federico Rabuffetti, University of Southern California: Mitigating Breakdown in High Energy Density Perovskite Polymer Nanocomposite Capacitors
ES045; Dmitry Bedrov, U of Utah: The Influence of Electrolyte Structure and Electrode Morphology on the Performance of Ionic-Liquid Based Supercapacitors: A
ES151; Harry Tuller, MIT: Chemomechanics of Far-From-Equilibrium Interfaces (COFFEI)
ES046; Janna Maranas, Pennsylvania State University: Conduction Mechanisms and Structure of Ionomeric Single-Ion Conductors
ES047; Nick Whelan, UC Santa Barbara/LifeCel Technology: Biological and Biomimetic Low-Temperature Routes to Materials for Energy Applications
ES152; Shen Dillon, UIUC: In-Situ TEM Observations of Degradation Mechanisms in Next-Generation High Energy Density Lithium-Ion Battery Systems
ES153; Nina Balke, ORNL: Spatially Resolved Ionic Diffusion and Electrochemical Reactions in Solids:
ES154; Delia Milliron, LBNL: Inorganic Nanocomposite Electrodes for Electrochemical Energy Storage and Energy Conservation
Vehicle and Systems Simulation
VSS088; Forrest Jehlik, ANL: Data Collection for Improved Cold Temperature Thermal Modeling
VSS089; Stuart Daw, ORNL: Advanced HD Engine Systems and Emissions Control Modeling and Analysis
VSS090; John Rugh, NREL: Electric Drive Vehicle Climate Control Load Reduction
VSS091; Eric Rask, ANL: Defining Real World Drive Cycles to Support APRF Technology Evaluations
VSS013; Paul Chambon, ORNL: PHEV Engine Control and Energy Management Strategy
VSS092; Andreas Maikopoulos, ORNL: Autonomous Intelligent Plug-In Hybrid Electric Vehicles (PHEVs)
VSS055; Krishnan Gowri, PNNL: Vehicle to Grid Communication Standards Development Support
Fuel & Lubricant Technologies
FT013; Teresa Alleman, NREL: Biofuels Quality Surveys
FT011; Aaron Williams, NREL: Impact of Biodiesel Metals on Aftertreatment System Durability

GRAND BALLROOM

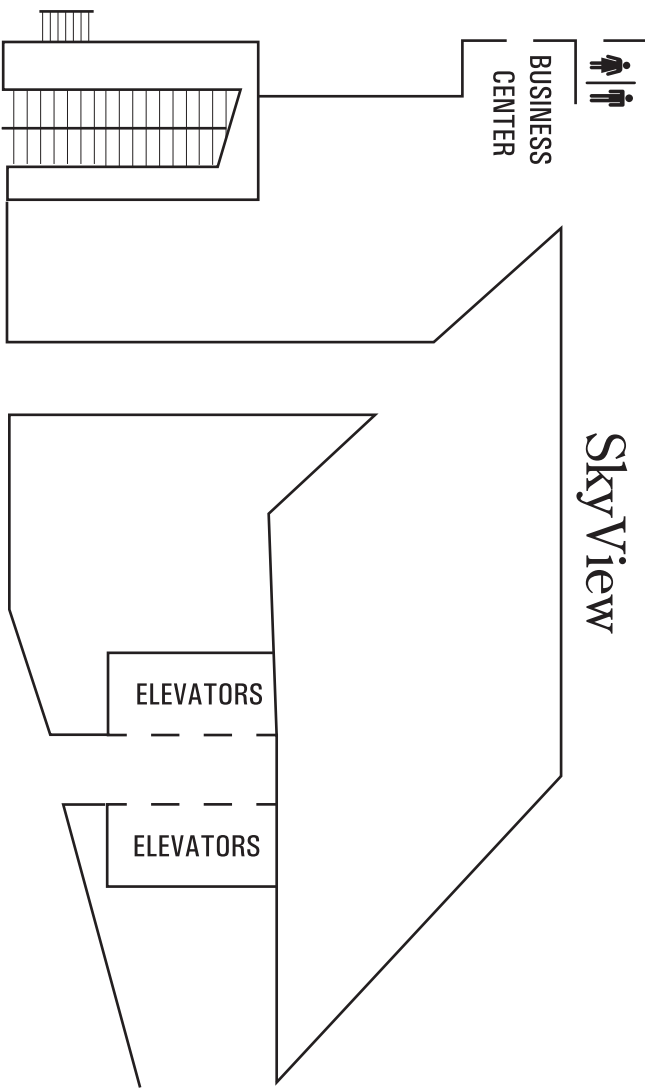
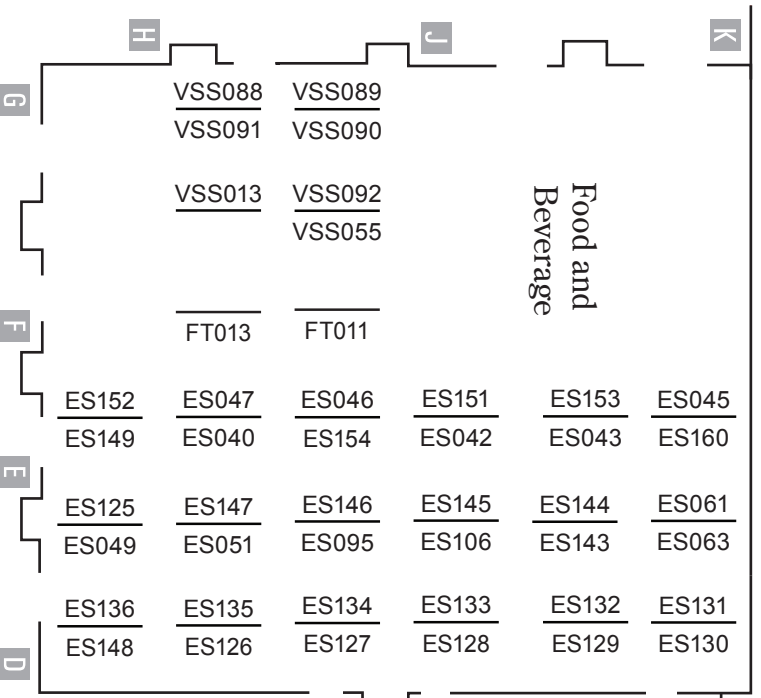

to MEZ
Restaurant

POSTER MAP

Monday, May 14

Crystal Gateway Marriott



2012 DOE ANNUAL MERIT REVIEW AND PEER EVALUATION MEETING

Tuesday, May 15 - Oral Presentations

Hotel	Crystal Gateway	Crystal Gateway	Crystal Gateway
Salon	I	II	III
8:15 AM	APE00A; Susan Rogers, DOE: Advanced Power Electronics and Electric Motors (APEEM)	AN000; Fred Joseck, DOE: Systems Analysis Session Introduction	
8:30 AM	APE004; Gui-Jia Su, ORNL: A Segmented Drive Inverter Topology with a Small DC Bus Capacitor	AN020; Marc Melaina, NREL: Hydrogen Refueling Infrastructure Cost Analysis	ES000; David Howell, DOE: Overview of Battery R&D Activities
9:00 AM	APE007; Madhu Chinthavali, ORNL: Wide Bandgap Materials	AN021; Marc Melaina, NREL: Comparing Infrastructure Costs for Hydrogen and Electricity	ES098; Chris Johnson, NETL: Progress of DOE Materials, Manufacturing Process R&D, and ARRA Battery Manufacturing Grants
9:30 AM	APE023; Zhenxian Liang, ORNL: Power Device Packaging	AN001; Brian Bush, NREL: Infrastructure Analysis of Early Market Transition of Fuel Cell Vehicles	ES097; Kent Snyder, Ford Motor Company: Overview and Progress of United States Advanced Battery Research (USABC) Activity
10:00 AM	APE040; Greg Smith, General Motors: Next Generation Inverter	AN022; Darlene Steward, NREL: Infrastructure Costs Associated with Central Hydrogen Production from Biomass and Coal	ES111; Kevin Gallagher, ANL: PHEV Battery Cost Assessment
10:30 AM	BREAK	BREAK	BREAK
11:00 AM	APE042; Madhu Chinthavali, ORNL: Air-Cooled Traction Drive Inverter	AN023; David Greene, ORNL: Sensitivity Analysis of H ₂ -Vehicles Market Prospects, Costs and Benefits	ES108; Tien Duong, DOE: Overview and Progress of the Batteries for Advanced Transportation Technologies (BATT) Activity
11:30 AM	APE033; Gui-Jia Su, ORNL: Converter Topologies for Wired and Wireless Battery Chargers	AN024; Mark Ruth, NREL: Effects of Technology Cost Parameters on Hydrogen Pathway Succession	ES014; Peter Faguy, DOE: Overview and Progress of the Applied Battery Research (ABR) Activity
12:00 PM	APE032; Christopher Whaling, Synthesis Partners: Interim Update: Global Automotive Power Electronics R&D Relevant To DOE 2015 and 2020 Cost Targets	AN025; Zhenhong Lin, ORNL: Impact of Program Goals on Hydrogen Vehicles: Market Prospect, Costs, and Benefits	ES116; Brian Cunningham, DOE: Overview and Progress of the Battery Testing, Analysis, and Design Activity
12:30 PM	LUNCH 1:00 PM - N. Whitcombe, Advanced Technology Vehicles Manufacturing Incentive Program 1:15 PM - Pat Davis, Vehicle Technologies Program Awards		
1:45 PM	APE008; Uthamalingam Balachandran, ANL: High Dielectric Constant Capacitors for Power Electronic Systems	AN026; Marc Melaina, NREL: Resource Analysis for Hydrogen Production	ES117; Ahmad Pesaran, NREL: Overview of Computer-Aided Engineering of Batteries (CAEBAT) and Introduction to Multi-Scale, Multi-Dimensional (MSMD) Modeling of Lithium-Ion Batteries
2:15 PM	APE009; Leah Appelkans, SNL: High Temperature Polymer Capacitor Dielectric Films	AN012; Michael Wang, ANL: Life-Cycle Analysis of Vehicle and Fuel Systems with the GREET Model	ES118; Steven Hartridge, CD-Adapco: Development of Computer-Aided Design Tools for Automotive Batteries
2:45 PM	APE027; Philip Neudeck, NASA: Development of SiC Large Tapered Crystal Growth	AN027; Mark Ruth, NREL: Cost, Energy Use, and Emissions of Tri-Generation Systems	ES119; Taeyoung Han, General Motors: Development of Computer-Aided Design Tools for Automotive Batteries
3:15 PM	APE039; Sreekant Narumanchi, NREL: Compact, Light-Weight, Single-Phase, Liquid-Cooled Cold Plate	AN029; Marianne Mintz, ANL: Employment Impacts of Early Markets for Hydrogen and Fuel Cell Technologies	ES120; Christian Shaffer, EC-Power: Development of Cell/Pack Level Models for Automotive Li-Ion Batteries with Experimental Validation
3:45 PM	BREAK	BREAK	BREAK
4:15 PM	APE028; Doug DeVoto, NREL: Thermal Performance and Reliability of Bonded Interfaces	AN028; William Ernst, Strategic Analysis, Inc.: Evaluation of U.S. DOE Energy Recovery Act Fuel Cell (Technologies Program) Initiative	ES121; Sreekanth Pannala, ORNL: Open Architecture Software for CAEBAT
4:45 PM	APE026; Allen Hefner, NIST: Electro-thermal-mechanical Simulation and Reliability for Plug-in Vehicle Converters and Inverters		ES122; Jon Christophersen, INL: Energy Storage Monitoring System and In-Situ Impedance Measurement Modeling
5:15 PM	APE019; Jason Lustbader, NREL: Air Cooling Technology for Power Electronic Thermal Control		ES123; Jeremy Neubauer, NREL: Applying the Battery Ownership Model in Pursuit of Optimal Battery Use Strategies
5:45 PM			ES124; Kevin Gering, INL: Diagnostic and Prognostic Analysis of Battery Performance & Aging based on Kinetic and Thermodynamic Principles

Tuesday, May 15 - Oral Presentations

Hotel Salon	Crystal Gateway IV	Crystal Gateway V	Crystal Gateway VI
8:15 AM	FC000; Dimitrios Papageorgopoulos, DOE: Fuel Cells Session Introduction	ST000; Ned Stetson, DOE: Hydrogen Storage Overview	VSS000; Lee Slezak, DOE: Overview of Vehicle and Systems Simulation and Testing
8:30 AM	FC006; Radoslav Atanasoski, 3M: Durable Catalysts for Fuel Cell Protection During Transient Conditions	ST001; Rajesh Ahluwalia, ANL: System Level Analysis of Hydrogen Storage Options	VSS065; Henning Lohse-Busch, ANL: Evaluation and Adaptation of 5-Cycle Fuel Economy Testing and Calculations for HEVs
9:00 AM	FC007; Bryan Pivovar, NREL: Extended, Continuous Pt Nanostructures in Thick, Dispersed Electrodes	ST100; Brian James, Strategic Analysis, Inc.: Hydrogen Storage Cost Analysis, Preliminary Results	VSS073; PT Jones, ORNL: NYC Taxi Drive Cycle Development and Simulation Study
9:30 AM	FC008; Nenad Markovic, ANL: Nanosegregated Cathode Catalysts with Ultra-Low Platinum Loading	ST004; Don Anton, SRNL: Hydrogen Storage Engineering Center of Excellence	VSS053; Ted Bohn, ANL: Codes and Standards to Support Vehicle Electrification
10:00 AM	FC009; Radoslav Adzic, BNL: Contiguous Platinum Monolayer Oxygen Reduction Electrocatalysts on High-Stability-Low-Cost Supports		VSS067; Keith Hardy, ANL: Grid Interaction Tech Team, and International Smart Grid Collaboration
10:30 AM	BREAK	BREAK	BREAK
11:00 AM	FC010; Fernando Garzon, LANL: The Science and Engineering of Durable Ultralow PGM Catalysts	ST044; David Tamburello, SRNL: SRNL Technical Work Scope for the Hydrogen Storage Engineering Center of Excellence:	VSS029; Don Karner, ecoTality North America: Advanced Vehicle Testing & Evaluation
11:30 AM	FC044; Eric Brosha, LANL: Engineered Nano-scale Ceramic Supports for PEM Fuel Cells	ST010; Mike Veenstra, Ford Motor: Ford/BASF-SE/UM Activities in Support of the Hydrogen Storage Engineering Center of Excellence	VSS030; Mike Duoba, ANL: Advanced Technology Vehicle Lab Benchmarking - Level 1
12:00 PM	FC085; Vijay Ramani, IIT: Synthesis and Characterization of Mixed-Conducting Corrosion Resistant Oxide Supports	ST009; Darsh Kumar, General Motors: Thermal Management of On-Board Cryogenic Hydrogen Storage Systems	VSS031; Eric Rask, ANL: Advanced Technology Vehicle Lab Benchmarking - Level 2 (in-depth)
12:30 PM	LUNCH 1:00 PM - N. Whitcombe, Advanced Technology Vehicles Manufacturing Incentive Program 1:15 PM - Pat Davis, Vehicle Technologies Program Awards		
1:45 PM	FC086; Sanjeev Mukerjee, Northeastern Univ: Development of Novel Non Pt Group Metal Electrocatalysts for Proton Exchange Membrane Fuel Cell Applications	ST045; Joseph Reiter, NASA JPL: Key Technologies, Thermal Management, and Prototype Testing for Advanced Solid-State Hydrogen Storage Systems	VSS068; Dominik Karbowski, ANL: Optimal Energy Management of a PHEV Using Trip Information
2:15 PM	FC087; Fred Wagner, GM: High-Activity Dealloyed Catalysts	ST046; Kevin Drost, Oregon State U: Microscale Enhancement of Heat and Mass Transfer for Hydrogen Energy Storage	VSS069; Eric Rask, ANL: Impact of Battery Management on Fuel Efficiency Validity
2:45 PM	FC088; Branko Popov, U of South Carolina: Development of Ultra-Low Platinum Alloy Cathode Catalyst for PEM Fuel Cells	ST047; Norman Newhouse, Lincoln Composites: Development of Improved Composite Pressure Vessels for Hydrogen Storage	VSS070; Namdoon Kim, ANL: Electric Drive Vehicle Level Control Development Under Various Thermal Conditions
3:15 PM	FC084; John Turner, NREL: WO3 and HPA Based Systems for Durable Pt Catalysts in PEMFC Cathodes	ST007; Troy Semelsberger, LANL: Chemical Hydride Rate Modeling, Validation, and System Demonstration	VSS046; John Rugh, NREL: Integrated Vehicle Thermal Management – Combining Fluid Loops in Electric Drive Vehicles
3:45 PM	BREAK	BREAK	BREAK
4:15 PM	FC012; Deborah Myers, ANL: Polymer Electrolyte Fuel Cell Lifetime Limitations: The Role of Electrocatalyst Degradation	ST005; Jamie Holladay, PNNL: Systems Engineering of Chemical Hydrogen, Pressure Vessel, and Balance of Plant for On-Board Hydrogen Storage	VSS043; Jeffrey Gonder, NREL: Medium- and Heavy-Duty Electric Drive Vehicle Simulation and Analysis
4:45 PM	FC001; Mark Debe, 3M: Advanced Cathode Catalysts and Supports for PEM Fuel Cells	ST006; Bart van Hassel, UTRC: Advancement of Systems Designs and Key Engineering Technologies for Materials Based Hydrogen	VSS071; Aymeric Rousseau, ANL: Hydraulic HEV Fuel Consumption Potential
5:15 PM		ST008; Matthew Thornton, NREL: System Design, Analysis, Modeling, and Media Engineering Properties for Hydrogen Energy Storage	VSS072; Andreas Malikopoulos, ORNL: The Meritor Dual Mode Hybrid Powertrain CRADA
5:45 PM			VSS061; John Miller, ORNL: Wireless Plug-in Electric Vehicle (PEV) Charging

Tuesday, May 15 - Oral Presentations

Hotel	Crystal Gateway
Salon	Alexandria
8:15 AM	
8:30 AM	PM000; Jerry Gibbs, DOE: Overview of Propulsion Materials
9:00 AM	PM005; Leta Woo, LLNL: NOx Sensor Development
9:30 AM	PM043; Dileep Singh, ANL: Compact Potentiometric O2/NOx Sensor
10:00 AM	PM010; Thomas Watkins, ORNL: Durability of Diesel Engine Particulate Filters
10:30 AM	BREAK
11:00 AM	PM041; Michael Lance, ORNL: Electrically-Assisted Diesel Particulate Filter Regeneration
11:30 AM	PM040; Michael Lance, ORNL: Biofuels Impact on DPF Durability
12:00 PM	PM009; Michael Lance, ORNL: Materials Issues Associated with EGR Systems
12:30 PM	LUNCH 1:00 PM - N. Whitcombe, Advanced Technology Vehicles Manufacturing Incentive Program 1:15 PM - Pat Davis, Vehicle Technologies Program Awards
1:45 PM	PM012; Andrew Wereszczak, ORNL: Thermoelectric Mechanical Reliability
2:15 PM	PM013; David J. Singh, ORNL: Thermoelectrics Theory and Structure
2:45 PM	PM036; Hua-Tay Lin, ORNL: Low-Cost Direct Bonded Aluminum (DBA) Substrates
3:15 PM	PM037; Andy Wereszczak, ORNL: Improved Organics for Power Electronics and Electric Motors
3:45 PM	BREAK
4:15 PM	PM038; Phil Maziasz, ORNL: Materials for Advanced Turbocharger Design
4:45 PM	PM039; Jeff Thomson, ORNL: Engine Materials Compatibility with Alternate Fuels
5:15 PM	PM004; Glenn Grant, PNNL : Novel Manufacturing Technologies for High Power Induction and Permanent Magnet Electric Motors
5:45 PM	PM044; Mark Smith, PNNL: High-Temperature Aluminum Alloys

Tuesday, May 15 - Oral Presentations

Hotel	Crystal City	Crystal City	Crystal City
Salon	D	E	F
8:15 AM	FT000; Kevin Stork, DOE: Fuel & Lubricant Technologies	ACE00A; Gurpreet Singh, DOE: Overview of DOE Advanced Combustion Engine R&D	SCS000; Antonio Ruiz, DOE: Safety, Codes and Standards Session Introduction
8:30 AM	FT012; George Fenske, ANL: Lubricants Activities	ACE001; Mark Musculus, SNL: Heavy-Duty Low-Temperature and Diesel Combustion & Heavy-Duty Combustion Modeling	SCS010; Isaac Ekoto, SNL: R&D for Safety Codes and Standards: Hydrogen Behavior
9:00 AM	FT002; Brad Zigler, NREL: Fuels for Advanced Combustion Engines	ACE002; Paul Miles, SNL: Low-Temperature Automotive Diesel Combustion	SCS005; Brian Somerday, SNL: R&D for Safety Codes and Standards: Materials and Components Compatibility
9:30 AM	FT003; Bob McCormick, NREL: Performance of Biofuels and Biofuel Blends	ACE004; John Dec, SNL: HCCI and Stratified-Charge CI Engine Combustion Research	SCS002; Robert Burgess, NREL: Component Standard Research & Development
10:00 AM	FT004; Chuck Mueller, SNL: Fuels and Combustion Strategies for High-Efficiency Clean-Combustion Engines	ACE005; Lyle Pickett, SNL: Spray Combustion Cross-Cut Engine Research	SCS011; Aaron Harris, SNL: R&D for Safety Codes and Standards: Risk Assessments
10:30 AM	BREAK	BREAK	BREAK
11:00 AM	FT006; Magnus Sjoberg, SNL: Advanced Lean-Burn DI Spark Ignition Fuels Research	ACE006; Richard Steeper, SNL: Automotive HCCI Engine Research	SCS007; Tommy Rockward, LANL: Hydrogen Fuel Quality
11:30 AM	FT007; Scott Sluder, ORNL: Fuel Effects on Emissions Control Technologies	ACE007; Joe Oefelein, SNL: Large Eddy Simulation (LES) Applied to Advanced Engine Combustion Research	SCS008; Steven Weiner, PNNL: Hydrogen Safety Panel
12:00 PM	FT008; James Szybist, ORNL: Gasoline-Like Fuel Effects on Advanced Combustion Regimes	ACE008; Terry Johnson, SNL: Free-Piston Engine	SCS013; William Hoagland, PNNL: International Energy Agency Hydrogen Implementing Agreement Task 31 Hydrogen Safety
12:30 PM	LUNCH - (Awards Ceremonies and Speakers will be in the Crystal Gateway hotel)		
1:45 PM	FT010; Bill Pitz, LLNL: Chemical Kinetic Modeling of Non-Petroleum Based Fuels	ACE075; Sibendu Som, ANL: Advancement in Fuel Spray and Combustion Modeling for Compression Ignition Engine Applications	SCS004; Eric Brosha, LANL: Hydrogen Safety, Codes and Standards: Sensors
2:15 PM	TI000; Dennis Smith, DOE: Technology Integration Overview	ACE010; Christopher Powell, ANL: Fuel Injection and Spray Research Using X-Ray Diagnostics	SCS001; Carl Rivkin, NREL: National Codes and Standards Coordination
2:45 PM	TI014; Ted Sears, NREL: 2012 Merit Review: EPA Act State and Alternative Fuel Provider Fleets	ACE011; Steve Ciatti, ANL: Use of Low Cetane Fuel to Enable Low Temperature Combustion	SCS006; Linda Fassbender, PNNL: Hydrogen Safety Knowledge Tools
3:15 PM	ARRAVT032; Steve Dunlop, Purdue U: Indiana Advanced Electric Vehicle Training and Education Consortium (I-AEVtec)	ACE012; Dan Flowers, LLNL: Computationally Efficient Modeling of High-Efficiency Clean Combustion Engines	SCS015; Monte Elmore, PNNL: Hydrogen Emergency Response Training for First Responders
3:45 PM	BREAK	BREAK	BREAK
4:15 PM	ARRAVT033; Gary Caille, Colorado State U: Advanced Electric Drive Vehicle Education Program: CSU Ventures	ACE013; Bill Pitz, LLNL: Chemical Kinetic Research on HCCI & Diesel Fuels	
4:45 PM	ARRAVT034; Mehdi Ferdowsi, Missouri U of Science and Technology: Advanced Electric Drive Vehicles – A Comprehensive Education, Training, and Outreach Program	ACE076; Matthew McNenly, LLNL: Improving Combustion Software to Solve Detailed Chemical Kinetics for HECC	
5:15 PM	ARRAVT037; Carl Anderson, Michigan Technological U: Recovery Act – An Interdisciplinary Program for Education and Outreach in Transportation Electrification	ACE014; David Carrington, LANL: 2012 KIVA-Development	
5:45 PM	ARRAVT039; Lawrence Schwendeman, J. Sargeant Reynolds Community College: Advanced Electric Drive Vehicles	ACE016; Scott Curran, ORNL: High Efficiency Clean Combustion in Multi-Cylinder Light-Duty Engines	

Tuesday, May 15 - Poster Presentations
Crystal Gateway Hotel - Grand Ballroom and SkyView, 6:30-8:30 PM

Electrochemical Storage
ES088: Nitash Balsara, LBNL : Polymers For Advanced Lithium Batteries
ES089: John Kerr, LBNL : Electrolytes - R&D for Advanced Lithium Batteries. Interfacial Behavior of Electrolytes
ES058: Dmitry Bedrov, U of Utah : Molecular dynamics simulation and ab initio studies of electrolytes and electrolyte/electrode interfaces
ES066: Khalil Amine, ANL: Electrolytes - Advanced Electrolyte and Electrolyte Additives
ES067: Brett Lucht, U of Rhode Island: Development of Electrolytes for Lithium-ion Batteries
ES068: Daniel Scherson, Case Western Reserve U: Bifunctional Electrolytes for Lithium-ion Batteries
ES057: Wesley Henderson, North Carolina State U: Inexpensive, Nonfluorinated (or Partially Fluorinated) Anions for Lithium Salts and Ionic Liquids for Lithium
ES100: Austen Angell, Arizona State University: Electrolytes and Separators for High Voltage Li Ion Cells
ES155: Jack Vaughey, ANL : Integrated Laboratory Industry Research Project
ES156: Gao Liu, LBNL: Integrated Laboratory and Industry Research Project
ES157: Nancy Dudney, ORNL: Composite Electrolyte to Stabilize Metallic Lithium Anodes
ES105: Chengdu Liang, ORNL: Carbon/Sulfur Nanocomposites and Additives for High-Energy Lithium Sulfur Batteries
ES075: Paul Mutolo, Cornell: Energy Materials Center at Cornell (emc ²): Advanced Materials for Fuel Cells and Batteries
ES076: Stanley Whittingham, Binghamton University-SUNY: Northeastern Center for Chemical Energy Storage (NECCES)
ES078: Gary Rubloff, U of Maryland: Science of Precision Multifunctional Nanostructures for Electrical Energy Storage
ES079: Grigori Soloveichik, General Electric: Center for Electrocatalysis, Transport Phenomena and Materials for Innovative Energy Storage
ES080: Michael Thackeray, ANL: Center for Electrical Energy Storage: Tailored Interfaces
ES158: Arumugam Manthiram, U of Texas: SOLID ELECTROLYTES FOR NEXT GENERATION BATTERIES
ES159: Arumugam Manthiram, U of Texas: Materials and Interfacial Chemistry for Next-Generation Electrical Energy Storage (partner with UT-Austin)
ES044: Shirley Meng, U of California at San Diego: New In Situ Analytical Electron Microscopy for Understanding Structure Evolution and Composition Change
ES073: Yuri Gogotsi, Drexel U: Silicon Carbide Derived Carbons: Experiments and Modeling
ES072: Jun Liu, PNNL: Molecularly Organized Nanostructured Materials
ES169: Yet-Ming Chiang, MIT: Electrochemically-Driven Phase Transitions in Battery Storage Compounds
ES170: Paul Sideris, CUNY-Hunter College: Spectroscopic Studies of Materials for Electrochemical Energy Storage
ES171: Pradeep Guduru, Brown University: Fundamental Investigations of Mechanical and Chemical Degradation Mechanisms in Lithium Ion Battery Materials
Advanced Power Electronics
APE006: Tim Burress, ORNL: Benchmarking of Competitive Technologies
APE046: Leon Tolbert, ORNL: Smart Integrated Power Module
APE047: Kevin Bennion, NREL: Integrated Module Heat Exchanger
APE037: Gilbert Moreno, NREL: Two-Phase Cooling Technology for Power Electronics
APE036: Doug DeVoto, NREL: Physics of Failure of Electrical Interconnects
APE010: Michael Lanagan, Penn State U: Glass Ceramic Dielectrics for DC Bus Capacitors
ARRAVT021: Judith Gieseking, General Motors: US Electric Drive Manufacturing Center
ARRAVT022: Greg Grant, Delphi Automotive Systems, LLC: Low-Cost U.S. Manufacturing of Power Electronics for Electric Drive Vehicles
ARRAVT023: Richard Thies, Allison Transmission, Inc.: Electric Drive Component Manufacturing Facilities
ARRAVT024: Kevin Poet, Ford Motor: U.S. Based HEV and PHEV Transaxle Program
ARRAVT025: Dane Carter, Remy, Inc.: Providing Vehicle OEMs Flexible Scale to Accelerate Adoption of Electric Drive Vehicles
ARRAVT026: Jon Lutz, UQM Technologies, Inc.: Electric Drive Component Manufacturing Facilities
ARRAVT027: Beth Sommers, Magna E-Car Systems of America, Inc.: Electric Drive Component Manufacturing: Magna E-Car Systems of America, Inc.
ARRAVT028: Johnny Boan, KEMET Corporation: DC Bus Capacitor Manufacturing Facility for Electric Drive Vehicles
ARRAVT029: Hugh Kirbie, SBE, Inc.: Construction, Qualification, and Low Rate Production Start - up of a DC Bus Capacitor High Volume Manufacturing
ARRAVT030: Duane Prusia, Powerex, Inc.: Electric Drive Semiconductor Manufacturing (EDSM) Center
Technology Integration
TI020: Chris Mi, Regents University of Michigan: Center for Electric Drive Transportation at the University of Michigan - Dearborn
TI021: Scott Trimboli, University of Colorado: Innovative Drivetrains in Electric Automotive Technology Education (IDEATE)
TI022: Geroqio Rizzoni, Ohio State University: GATE: Energy Efficient Vehicles for Sustainable Mobility
TI023: Gregory Shaver, Purdue University: Hoosier Heavy Hybrid Center of Excellence
TI024: Imtiaz Haque, Clemson University: GATE Center of Excellence in Sustainable Vehicle Systems
TI025: Joel Anstrom, Pennsylvania State University: IN-VEHICLE, HIGH-POWER ENERGY STORAGE SYSTEMS
TI026: Uday Vaidya, University of Alabama: GATE Center of Excellence in Lightweight Materials and Manufacturing Technologies
Fuel Cells
FC100: Brian Larsen, NREL: High Aspect Ratio Nano-Structured Pt-based PEM Fuel Cell Catalysts
FC011: John Kerr, LBNL: Molecular-scale, Three-dimensional Non-Platinum Group Metal Electrodes for Catalysis of Fuel Cell Reactions
FC027: Brian Carnes, SNL: Development and Validation of a Two-phase, Three-dimensional Model for PEM Fuel Cells
FC051: Ira Bloom, ANL: The Fuel Cell Testing at the Argonne Fuel Cell Test Facility
FC052: Tommy Rockward, LANL: Technical Assistance to Developers
FC101: Shriram Ramanathan, UTC Power: PEM Stationary Power Plant
FC002: Lesia Protsailo, UTC Power: Highly Dispersed Alloy Catalyst for Durability
FC015: Timothy Patterson, UTC Power: Improved Accelerated Stress Tests Based on FCV Data
FC025: Dave Hancock, Plug Power, Inc.: Air Cooled Stack Freeze Tolerance
FC030: Vernon Cole, CFD Research Corp.: Water Transport in PEM Fuel Cells: Advanced Modeling, Material Selection, Testing, and Design Optimization
FC031: Durai Swamy, Intelligent Energy: Development and Demonstration of a New Generation High Efficiency 10kW Stationary PEM Fuel Cell System
FC043: Yu Seung Kim, LANL: Resonance-Stabilized Anion Exchange Polymer Electrolytes
FC102: Earl Wagener, Tetramer Technologies, LLC: New High Performance Water Vapor Membranes To Improve Fuel Cell Balance of Plant Efficiency and Low
FC070: Steven Chuang, U of Akron: Development of Kilowatt-Scale Coal Fuel Cell Technology
FC072: Anant Upadhvavula, Rolls-Royce Fuel Cell Systems (US) Inc.: Extended Durability Testing of an External Fuel Processor for SOFC
FC076: Neal Sullivan, Colorado School of Mines: Biomass Fuel Cell Systems
FC078: Joel Berry, Kettering U: 21st Century Renewable Fuels, Energy, and Materials Initiative
FC079: Prabhakar Singh, University of Connecticut Global Fuel Cell Center: Improving Fuel Cell Durability and Reliability
FC075: Vern Sproat, Stark State College: Fuel Cell Balance of Plant Reliability Testbed
Hydrogen Production and Delivery
PD065: Timothy Norman, Giner Electrochemical Systems, LLC: Unitized Design for Home Refueling Appliance for Hydrogen Generation to 5,000 psi
PD067: Luke Dalton, Proton OnSite: Hydrogen by Wire - Home Fueling System
PD076: Mano Misra, U of Nevada Reno: Photoelectrochemical Generation of Hydrogen from Water Using Nanotube-Based Semiconductor Systems for
PD079: Wai-Ning Mei, U of Nebraska - Omaha: Novel Photocatalytic Metal Oxides
PD077: Ravi Subramanian, U of Nevada Reno: Solar Energy Utilization
PD082: Glenn Eisman, H2 Pump LLC: Process Intensification of Hydrogen Unit Operations Using an Electrochemical Device
PD085: Chris Ainscough, NREL: Hour-by-Hour Cost Modeling of Optimized Central Wind-Based Water Electrolysis Production
PD089: Darlene Steward, NREL: H2A Hydrogen Production Analysis Model Version 3
PD090: Christopher Capuano, Proton OnSite: Low Cost Large Scale PEM Electrolysis for Renewable Energy Storage
PD020: Andrew Weisberg, LLNL: Inexpensive Delivery of Cold Hydrogen in Glass Fiber Composite Pressure Vessels
PD091: Gokhan Alptekin, TDA Research: Bio-Fueled Solid Oxide Fuel Cells

GRAND BALLROOM

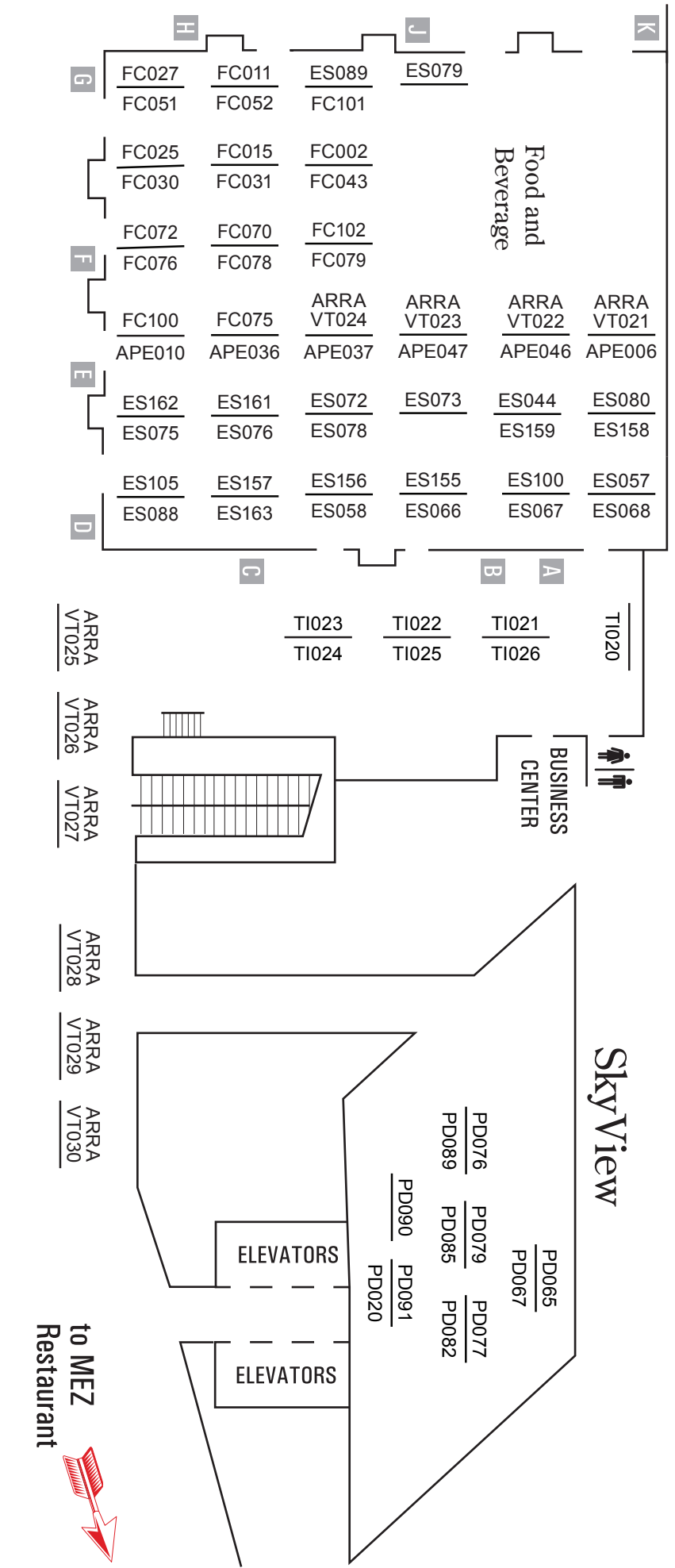

POSTER MAP

Tuesday, May 15

Crystal Gateway Marriott



2012 DOE ANNUAL MERIT REVIEW AND PEER EVALUATION MEETING

Wednesday, May 16 - Oral Presentations

Hotel	Crystal Gateway	Crystal Gateway	Crystal Gateway
Salon	I	II	III
8:15 AM		PD000; Eric Miller, DOE: Hydrogen Production Session Introduction	
8:30 AM	APE030; Kevin Bennion, NREL: Electric Motor Thermal Management	PD037; Maria Ghirardi, NREL: Biological Systems for Hydrogen Photoproduction	ES015; Khalil Amine, ANL: Engineering of High Energy Cathode Materials
9:00 AM	APE015; Iver Anderson, Ames: Permanent Magnet Development for Automotive Traction Motors	PD038; Pin-Ching Maness, NREL: Fermentation and Electrohydrogenic Approaches to Hydrogen Production	ES019; Michael Thackeray, ANL: Development of High-Capacity Cathode Materials with Integrated Structures
9:30 AM	APE043; John Miller, ORNL: Alnico and Ferrite Hybrid Excitation Electric Machines	PD039; Phil Weyman, J Craig Venter Inst.: Hydrogen from Water in a Novel Recombinant Oxygen-Tolerant Cyanobacterial System	ES115; Christopher Johnson, ANL: Novel Composite Cathode Structures
10:00 AM	APE044; Jon Lutz, UQM Technologies, Inc.: Unique Lanthide-Free Motor Construction	PD036; Tasios Melis, UC Berkeley: Maximizing Light Utilization Efficiency and Hydrogen Production in Microalgal Cultures	ES016; Khalil Amine, ANL: New High Energy Gradient Concentration Cathode Material
10:30 AM	BREAK	BREAK	BREAK
11:00 AM	APE045; Ayman El-Refaie, General Electric Global: Alternative High-Performance Motors with Non-Rare Earth Materials	PD033; Thomas Jaramillo, Stanford U/NREL: Directed Nano-scale and Macro-scale Architectures for Semiconductor Absorbers and Transparent Conducting Substrates for Photoelectrochemical Water Splitting	ES028; Wenquan Lu, ANL: Screening of Electrode Materials & Cell Chemistries and Streamlining Optimization of Electrodes
11:30 AM	APE035; John Miller, ORNL: Motor Packaging with Consideration of Electromagnetic and Material Characteristics	PD035; Todd Deutsch, NREL: Semiconductor Materials for Photoelectrolysis	ES029; Vince Battaglia, LBNL: Scale-up and Testing of Advanced Materials from the BATT Program
12:00 PM	APE034; Burak Ozpineci, ORNL: Integration of Novel Flux Coupling Motor and Current Source Inverter	PD053; Jian Hu, MVSystems/HNEI: Photoelectrochemical Hydrogen Production	ES161; Anthony Burrell, ANL: Addressing the Voltage Fade Issue with Lithium-Manganese-Rich Oxide Cathode Materials
12:30 PM	LUNCH 12:55 PM - Presentation by Carl Maronde from NETL 1:10 PM - Sunita Satyapal, Hydrogen and Fuel Cells Program Awards		
1:45 PM		PD013; Serguei Lvov, PSU: Electrolyzer Development for the Cu-Cl Thermochemical Cycle	ES032; Dan Abraham, ANL: Diagnostic Studies on Lithium Battery Cells and Cell Components
2:00 PM	MN000; Nancy Garland, DOE: Manufacturing R&D Session Introduction		
2:15 PM	MN001; Michael Ulsh, NREL: Fuel Cell MEA Manufacturing R&D	PD027; Roger Davenport, SAIC: Solar High-Temperature Water Splitting Cycle with Quantum Boost	ES033; Robert Kostecki, LBNL : Electrochemistry Diagnostics of Baseline and New Materials
2:45 PM	MN004; Colin Busby, W.L. Gore: Manufacturing of Low-Cost, Durable Membrane Electrode Assemblies Engineered for Rapid Conditioning	PD081; Ivan Ermanoski, SNL: Solar Hydrogen Production with a Metal Oxide Based Thermochemical Cycle	ES034; Xiao-Qing Yang, BNL : Diagnostic Studies to Improve Abuse Tolerance and Life of Li-ion Batteries
3:15 PM	MN005; Dan Walczyk, Rensselaer Polytechnic Institute : Adaptive Process Controls and Ultrasonics for High Temperature PEM MEA	PD028; Al Weimer, U of Colorado: Solar-Thermal ALD Ferrite-Based Water Splitting Cycles	ES031; Kevin Gallagher, ANL: Electrochemistry Cell Model
3:45 PM	BREAK	BREAK	BREAK
4:15 PM	MN006; Eric Stanfield, NIST: Metrology for Fuel Cell Manufacturing	PD030; Monjid Hamdan, Giner Electrochemical Systems, LLC: PEM Electrolyzer Incorporating an Advanced Low Cost Membrane	ES096; Kevin Gering, INL : Diagnostic Testing and Analysis Toward Understanding Aging Mechanisms and Related Path Dependence
4:45 PM	MN007; Emory De Castro, BASF: High Speed, Low Cost Fabrication of Gas Diffusion Electrodes for Membrane Electrode Assemblies	PD071; Katherine Ayers, Proton OnSite: High Performance, Low Cost Hydrogen Generation from Renewable Energy	ES114; Vilas Pol, ANL: High Capacity Composite Carbon Anodes
5:15 PM		PD029; Paul Dunn, Avalence LLC: High-Capacity, High Pressure Electrolysis System with Renewable Power Sources	ES020; Ali Abouimrane, ANL: Developing A New High Capacity Anode With Long Cycle Life
5:45 PM		PD031; Kevin Harrison, NREL: Renewable Electrolysis Integrated System Development and Testing	ES163; Ilias Belharouak, ANL: Design of Safer High-Energy Density Materials for Lithium-Ion Cells

Wednesday, May 16 - Oral Presentations

Hotel	Crystal Gateway	Crystal Gateway	Crystal Gateway
Salon	IV	V	VI
8:15 AM			
8:30 AM	FC013; Rod Borup, LANL: Durability Improvements Through Degradation Mechanism Studies	ST023; Randy Snurr, Northwestern U: New Carbon-Based Porous Materials with Increased Heats of Adsorption for Hydrogen Storage	VSS021; Matt Shirik, INL: Idaho National Laboratory Testing of Advanced Technology Vehicles
9:00 AM	FC049; David Harvey, Ballard: Development of Micro-Structural Mitigation Strategies for PEM Fuel Cells: Morphological Simulations and Experimental Approaches	ST022; William Goddard, Caltech: A Joint Theory and Experimental Project in the Synthesis and Testing of Porous COFs for On-Board Vehicular Hydrogen Storage	VSS001; Kevin Walkowicz, NREL: Medium and Heavy-Duty Vehicle Field Evaluations
9:30 AM	FC014; Olga Polevaya, Nuvera Fuel Cells: Durability of Low Pt Fuel Cells Operating at High Power Density	ST018; Trevor Makal, Texas A&M U: Improving Porosity and H ₂ -Affinity of Porous Framework Materials	VSS033; Barney Carlson, INL: Electric Drive and Advanced Battery and Components Testbed (EDAB)
10:00 AM	FC089; Randy Perry, Dupont: Analysis of Durability of MEAs in Automotive PEMFC Applications	ST019; Peter Pfeifer, U of Missouri: Multiply Surface-Functionalized Nanoporous Carbon for Vehicular Hydrogen Storage	VSS074; Barney Carlson, INL: Vehicle Mass Impact on Vehicle Losses and Fuel Economy
10:30 AM	BREAK	BREAK	BREAK
11:00 AM	FC016; Rangachary Mukundan, LANL: Accelerated Testing Validation	ST024; Angela Lueking, Penn State U: Hydrogen Trapping through Designer Hydrogen Spillover Molecules with Reversible	VSS075; Jason Lustbader, NREL: CoolCab Test and Evaluation and CoolCalc HVAC Tool Development
11:30 AM	FC048; Huyen Dinh, NREL: Effect of System Contaminants on PEMFC Performance and Durability	ST014; Phil Parilla, NREL: Hydrogen Sorbent Measurement Qualification and Characterization	VSS045; Jason Lustbader, NREL: A/C Model Development and Validation
12:00 PM	FC065; Jean St-Pierre, Hawaii Natural Energy Institute: The Effect of Airborne Contaminants on Fuel Cell Performance and Durability	ST021; Thomas Gennett, NREL: Weak Chemisorption Validation	VSS076; Tony Markel, NREL: Mitigation of Vehicle Fast Charge Grid Impacts with Renewables and Energy Storage
12:30 PM	LUNCH 12:55 PM - Presentation by Carl Maronde from NETL 1:10 PM - Sunita Satyapal, Hydrogen and Fuel Cells Program Awards		
1:45 PM	FC096; Patricia Irving, InnovaTek: Power Generation from an Integrated Biomass Reformer and Solid Oxide Fuel Cell (SBIR Phase III)		VSS041; Stuart Daw, ORNL: Advanced LD Engine Systems and Emissions Control Modeling and Analysis
2:00 PM		BES001; John Vetrano, BES: Overview of the BES Hydrogen Storage Activities	
2:15 PM	FC032; Norman Bessette, Acumentrics Corporation: Development of a Low Cost 3-10kW Tubular SOFC Power System	BES002; Taner Yildirim, NIST: From Fundamental Understanding to Predicting New Nanomaterials for High-Capacity Hydrogen Storage	VSS077; Neeraj Shidore, ANL: Fuel Consumption and Cost Benefits of DOE Vehicle Technologies Program
2:45 PM	FC042; Randy Petri, Versa Power: Advanced Materials for RSOFC Dual Operation with Low Degradation	BES003; Timo Thonhauser, Wake Forest University: Novel theoretical and experimental approaches for understanding and optimizing hydrogen-sorbent interactions in metal organic framework materials	VSS078; Aymeric Rousseau, ANL: Fuel Displacement & Cost Potential of CNG, LNG, and LPG Vehicles
3:15 PM	FC041; Huyen Dinh, NREL: Novel Approach to Advanced Direct Methanol Fuel Cell Anode Catalysts	BES004; Hani El-Kaderi, VCU: Design and Synthesis of Chemically and Electronically Tunable Nanoporous Organic Polymers for Use in Hydrogen Storage Applications	VSS005; George Fenske, ANL: DOE/DOD Parasitic Energy Loss Collaboration
3:45 PM	BREAK	BREAK	BREAK
4:15 PM	FC063; David Mountz, Arkema: Novel Materials for High Efficiency Direct Methanol Fuel Cells	BES005; Nidia Gallego, ORNL: Atomistic Mechanisms of Metal-Assisted Hydrogen Storage in Nanostructured Carbons	VSS079; Wen Yu, ANL: PACCAR CRADA: Experimental Investigation in Coolant Boiling in a Half-Heated Circular Tube
4:45 PM	FC064; Jim Fletcher, U of North Florida: New MEA Materials for Improved DMFC Performance, Durability, and Cost	BES006; Ragaiy Zidan, SRNL: Elucidation of Hydrogen Interaction Mechanisms with Metal-Doped Carbon Nanostructures	VSS058; Oyelayo Ajayi, ANL: Development of High Power Density Driveline for Vehicles
5:15 PM	FC091; Piotr Zelenay, LANL: Advanced Materials and Concepts for Portable Power Fuel Cells	BES007; Pingyun Feng, UCR: Synthetic Design of New Metal-Organic Framework Materials for Hydrogen Storage	VSS006; Kambiz Salari, LLNL: DOE's Effort to Reduce Truck Aerodynamic Drag through Joint Experiments and Computations
5:45 PM		BES008; Peter Pfeifer, UMC: Networks of Boron-Doped Carbon Nanopores for Low-Pressure Reversible Hydrogen Storage	VSS080; Tanju Sofu, ANL: Integrated External Aerodynamic and Underhood Thermal Analysis for Heavy Vehicles

Wednesday, May 16 - Oral Presentations

Hotel	Crystal Gateway
Salon	Alexandria
8:15 AM	
8:30 AM	LM000; Carol Schutte, DOE: Summary of the Output from the VTP Advanced Materials
9:00 AM	LM001; Dave Warren, ORNL: Technical Cost Modeling - Life Cycle Analysis Basis for Program Focus
9:30 AM	LM048; George Husman, Zoltek: Development and Commercialization of a Novel Low-Cost Carbon Fiber
10:00 AM	LM047; Jim Stike, Materials Innovation Tech: Low Cost Carbon Fiber Composites for Lightweight Vehicle Parts
10:30 AM	BREAK
11:00 AM	LM003; Cliff Eberle, ORNL: Carbon Fiber Technology Facility
11:30 AM	LM004; Amit Naskar, ORNL: Lower Cost Carbon Fiber Precursors
12:00 PM	LM006; Felix Paulauskas, ORNL: Advanced Oxidation & Stabilization of PAN-Based Carbon Precursor Fibers
12:30 PM	LUNCH 12:55 PM - Presentation by Carl Maronde from NETL 1:10 PM - Sunita Satyapal, Hydrogen and Fuel Cells Program Awards
1:45 PM	LM049; Hamid Kia, USAMP/ACC: Structural Automotive Components from Composite Materials
2:15 PM	LM046; David Wagner, USAMP/ACC: Advanced Materials and Processing of Composites for High Volume Applications (ACC932)
2:45 PM	LM050; Martin Jones, USAMP/NDE: Reliability Tools for Resonance Inspection of Light Metal Castings
3:15 PM	LM051; Martin Jones, USAMP/NDE: Hybrid NDE Method for Spot Weld Quality Evaluation
3:45 PM	BREAK
4:15 PM	LM052; Yar-Ming Wang, USAMP/AMD: Development of Steel Fastener Nano-Ceramic
4:45 PM	LM053; Yar-Ming Wang, USAMP/AMD: Development of Corrosion Inhibiting E-Coat System for Body-in-White Assemblies
5:15 PM	LM054; Zhili Feng, ORNL: On-Line Weld NDE with IR Thermography
5:45 PM	

Wednesday, May 16 - Oral Presentations

Hotel	Crystal City	Crystal City	Crystal City
Salon	D	E	F
8:15 AM			MT000; Pete Devlin, DOE: Market Transformation Session Introduction
8:30 AM	ARRAVT035; Ka Yuen Simon Ng, Wayne State U: Development and Implementation of Degree Programs in Electric Drive Vehicle Technology	ACE017; Dean Edwards, ORNL: High Efficiency Engine Systems Development and Evaluation	MT004; Todd Ramsden, NREL: Direct Methanol Fuel Cell Material Handling Equipment Deployment
9:00 AM	ARRAVT036; Andrew Klock, National Fire Protection Association: Electric Vehicle Safety Training for Emergency Responders	ACE019; Margaret Wooldridge, U of Michigan: A University Consortium on Efficient and Clean High-Pressure, Lean Burn (HPLB) Engines	MT006; Dale King, PNNL: Fuel Cell Combined Heat and Power Commercial Demonstration
9:30 AM	ARRAVT038; Huei Peng, U of Michigan : Recovery Act—Transportation Electrification Education Partnership for Green Jobs and Sustainable Mobility	ACE020; Rolf Reitz, U of Wisconsin: Optimization of Advanced Diesel Engine Combustion Strategies	MT008; Richard Rocheleau, Hawaii Natural Energy Institute: Hydrogen Energy Systems as a Grid Management Tool
10:00 AM	ARRAVT040; Gerald Bernstein, City College of San Francisco: Electric Vehicle Service Personnel Training Program	ACE021; Gouming Zhu, Michigan State U: Flex Fuel Optimized SI and HCCI Engine	MT007; Russ Keller, South Carolina Hydrogen and Fuel Cell Alliance: Landfill Gas-to-Hydrogen
10:30 AM	BREAK	BREAK	BREAK
11:00 AM	ARRAVT031; Al Ebron, West Virginia U: Advanced Electric Drive Vehicle Education Program	ACE015; Stuart Daw, ORNL: Stretch Efficiency for Combustion Engines: Exploiting New Combustion Regimes	
11:30 AM	TI017; Al Ebron, West Virginia U: National Alternative Fuels Training Consortium (NAFTC)	ACE052; Todd Toops, ORNL: Neutron Imaging of Advanced Engine Technologies	
12:00 PM		ACE054; Steve Ciatti, ANL: Collaborative Combustion Research with BES	
12:30 PM	LUNCH - (Awards Ceremonies and Speakers will be in the Crystal Gateway hotel)		
1:30 PM		ACE00B; Ken Howden, DOE: Overview of DOE Emission Control R&D	H2RA000; Jim Alkire, DOE: Fuel Cell Technologies ARRA Projects Session
1:45 PM	ARRAVT044; Kelly Lynn, San Bernardino Associated Governments: SANBAG - Ryder Natural Gas Vehicle Project	ACE022; Jae-Soon Choi, ORNL: CLEERS Coordination & Joint Development of Benchmark Kinetics for LNT & SCR	H2RA013; Jennifer Kurtz, NREL: Analysis Results for ARRA Projects: Enabling Fuel Cell Market Transformation
2:15 PM	ARRAVT045; Vicki White, South Coast Air Quality Management District: Heavy-Duty Natural Gas Drayage Truck Replacement Program	ACE023; George Muntean, PNNL: CLEERS Aftertreatment Modeling and Analysis	H2RA012; Kevin Kenny, Sprint: Use of 72-Hour Hydrogen PEM Fuel Cell Systems to Support Emergency Communications
2:45 PM	ARRAVT047; Larry Watkins, South Coast Air Quality Management District: UPS Ontario - Las Vegas LNG Corridor Extension Project: Bridging the Gap	ACE024; Kyeong Lee, ANL: Development of Advanced Particulate Filters	H2RA007; Donald Rohr, Plug Power Inc.: Accelerating Acceptance of Fuel Cell Backup Power Systems
3:15 PM	ARRAVT082; Robert Bowen, California Department of General Services: California Low Carbon Fuels Infrastructure Investment Initiative	ACE025; Ken Rappe, PNNL: Combination and Integration of DPF-SCR Aftertreatment Technologies	H2RA003; Donald Rohr, Plug Power Inc.: Highly Efficient, 5kW CHP Fuel Cells Demonstrating Durability and Economic Value in Residential and Light Commercial Applications
3:45 PM	BREAK	BREAK	BREAK
4:15 PM	ARRAVT060; Don Francis, DeKalb County: DeKalb County/Metropolitan Atlanta Alternative Fuel and Advanced Technology Vehicle Project	ACE026; Chuck Peden, PNNL: Enhanced High Temperature Performance of NOx Storage/Reduction (NSR) Materials	H2RA002; Dan Hennessy, Delphi Automotive: Solid Oxide Fuel Cell Diesel Auxiliary Power Unit Demonstration
4:45 PM	ARRAVT062; Tom Stratton, Kentucky Department of Education: Kentucky Hybrid Electric School Bus Program	ACE027; Chuck Peden, PNNL: Degradation Mechanisms of Urea Selective Catalytic Reduction Technology	H2RA011; Bob Simon, GENCO: GENCO Fuel Cell Powered Lift Truck Fleet Deployment
5:15 PM	ARRAVT064; Kathy Boyer, Triangle J Council of Government: Carolina Blue Skies & Green Jobs Initiative	ACE028; Gordon Parker, Michigan Technological U: Experimental Studies for DPF and SCR Model, Control System, and OBD Development for Engines Using Diesel and Biodiesel Fuels	H2RA009; John King, FedEx Freight: Fuel Cell-Powered Lift Truck FedEx Freight Fleet Deployment
5:45 PM	ARRAVT065; Peter Denbigh, Virginia Department of Mines, Minerals and Energy: Southeast Propane AutoGas Development Program	ACE029; Michael Harold, U of Houston: Development of Optimal Catalyst Designs and Operating Strategies for Lean NOx Reduction in Coupled LNT-SCR Systems	H2RA010; Scott Kliever, Sysco of Houston: Fuel Cell-Powered Lift Truck Sysco Houston Fleet Deployment

Wednesday, May 16 - Poster Presentations

Crystal Gateway Hotel - Grand Ballroom, 6:30-8:30 PM

Electrochemical Storage
ES002; Mohamed Alamgir, LG Chem, Michigan: A High-Performance PHEV Battery Pack
ES003; Anne Testoni, A123Systems : USABC LEESS and PHEV Programs
ES005; Avie Judes, Johnson Controls-Saft : JCS PHEV System Development-USABC
ES008; Richard Pekala, Entek: Multifunctional, Inorganic-Filled Separators for Large Format, Li-ion Batteries
ES137; Herman Lopez, Envia: Development of High Energy Lithium Batteries for Electric Vehicles
ES138; Nick Karditsas, Cobasys: USABC Development of Advanced High-Performance Batteries for EV Applications
ES139; Kimberly McGrath, Maxwell: LEESS Battery Development
ES140; Keith Kepler, Farasis: Lithium Source For High Performance Li-ion Cells
ES141; Fraser Seymour, Ionova: 3-D Nanofilm Asymmetric Ultracapacitor
ES142; Suresh Sriramulu, TIAX: Implantation, Activation, Characterization and Prevention/Mitigation of Internal Short Circuits in Lithium-Ion Cells
ARRAVT001; Randy Koo, LG Chem, Michigan: Advanced Li-Ion Polymer Battery Cell Manufacturing Plant in USA
ARRAVT002; Rick Greenly, East Penn Manufacturing Co.: Advanced Battery Manufacturing Facilities and Equipment Program
ARRAVT003; Robert Kamischke, Enerdel : Expanding U.S.-based Lithium-ion Battery Manufacturing
ARRAVT004; Larry Atkins, Exide Technologies: Accelerating the Electrification of U.S. Drive Trains: Ready and Affordable Technology Solutions for Domestically
ARRAVT005; Linda Trumm, General Motors: GM Li-Ion Battery Pack Manufacturing
ARRAVT006; John Pham, KD ABG MI, LLC (Dow Kokam): Dow Kokam Lithium Ion Battery Production Facilities
ARRAVT007; Karen Conner, Saft America, Inc.: Saft Factory of the Future
ARRAVT008; Joseph Dicarolo, BASF Catalysts LLC: Construction of a Li Ion Battery (LIB) Cathode Production Plant in Elyria, Ohio
ARRAVT009; Gerry Rumierz, Celgard: Celgard US Manufacturing Facilities Initiative for Lithium-ion Battery Separator
ARRAVT010; John Groves, Chemetall Foote Corp: Expansion of Domestic Production of Lithium Carbonate and Lithium Hydroxide to Supply US Battery Industry
ARRAVT011; Chris Wheaton, EnerG2 Inc.: Recovery Act:Nanoengineered Ultracapacitor Material Surpasses the \$/kW Threshold for Use in EDVs
ARRAVT013; Jeff Lauinger , HTTM LLC: Manufacture of Advanced Battery Metal Containers & Components
ARRAVT014; Brian O'Leary, Honeywell: High-Volume Manufacturing of LiPF6, A Critical Lithium-ion Battery Material
ARRAVT015; Ralph Wise, Novolyte Technologies Inc: Expansion of Novolyte Capacity for Lithium Ion Electrolyte Production
ARRAVT016; Michael Sekedat, Pyrotek Inc.: Pyrotek Graphitization Facility Expansion Project
ARRAVT017; David Han, Toda America, Inc.: Toda Material/Component Production Facilities
ARRAVT018; Jesus Alvarez, A123Systems : Vertically Integrated Mass Production of Automotive Class Lithium Ion Batteries
ARRAVT019; Eric Ellerman, Johnson Controls, Inc: Johnson Controls Inc. Domestic Advanced Battery Industry Creation Project
ARRAVT020; Todd Coy, TOXCO Inc.: Lithium-Ion Battery Recycling Facilities
Hydrogen Storage
ST101; Kevin Simmons, PNNL: Enhanced Materials and Design Parameters for Reducing the Cost of Hydrogen Storage Tanks
ST052; Karl Gross, H2 Technology Consulting LLC: Best Practices for Characterizing Engineering Properties of Hydrogen Storage Materials
ST085; Kristina Lipinska-Kalita, U of Nevada Las Vegas: Glasses and Nanocomposites for Hydrogen Storage
ST102; John Vaio, HRL Laboratories, LLC: Room Temperature Hydrogen Storage in Nano-Confined Liquids
ST103; Jeffrey Long, LBNL: Hydrogen Storage in Metal-Organic Frameworks
BES009; Maddury Somayazulu, Carnegie Institute of Washington: Novel Molecular Materials for Hydrogen Storage Applications
BES010; Carolyn Koh, CSM: Energy Storage in Clathrate Hydrogen Material
BES011; Angela Lueking, PSU: Hydrogen Caged in Carbon—Exploration of Novel Carbon-Hydrogen Interactions
BES012; Marek Pruski, Ames Laboratory: Complex Hydrides - A New Frontier for Future Energy Applications
BES013; Jason Graetz, BNL: Atomistic Transport Mechanisms in Aluminum-Based Hydrides
ST034; Jim Wegrzyn, BNL: Aluminum Hydride
BES014; Chris Wolverton, NWU: Kinetics and Thermodynamics of Metal and Complex Hydride Nanoparticles
BES015; Chris Van de Walle, UCSB: Computational studies of hydrogen interactions with storage materials
BES016; Mark Conradi, WUSL: In Situ NMR Studies of Hydrogen Storage Systems
BES019; Tom Autrey, PNNL: Control of Hydrogen Release and Uptake in Condensed Phases
BES020; Christine Caputo, UCSD: Activation of Hydrogen Under Ambient Conditions by Main Group Molecules
BES021; Tom Baker, University of Ottawa: Chemical Hydrogen Storage in Ionic Liquid Media
BES023; Jihua Chen, FIU: Influence of Pressure on Physical Property of Ammonia Borane and its Re-hydrogenation
ST104; Shih-Yuan Liu, U of Oregon: Novel Carbon(C)-Boron(B)-Nitrogen(N)-Containing H2 Storage Materials
ST063; Ragaiy Zidan, SRNL: Electrochemical Reversible Formation of Alane
ST105; Dongsheng Mao, Applied Nanotech, Inc.: Ultra Lightweight High Pressure Hydrogen Fuel Tanks Reinforced with Carbon Nanotubes
ST106; Mark Leavitt, Quantum Fuel Systems Technologies Worldwide: Alternative Fiber Evaluation and Optimization of Filament Winding
ST107; Raina Olsen, ORNL: The Quantum Effects of Pore Structure on Hydrogen Adsorption
Hydrogen Production and Delivery
PD058; Tadashi Ogitsu, LLNL/NREL: Characterization and Optimization of Photoelectrode Surfaces for Solar-to-Chemical Fuel Conversion
PD056; Liwei Xu, Midwest Optoelectronics, LLC: Critical Research for Cost-Effective Photoelectrochemical Production of Hydrogen
PD052; Muhammad Huda, University of Texas at Arlington: PEC Materials: Theory and Modeling
PD051; Clemens Heske, U of Nevada Las Vegas: Surface Validation: Physical and Electronic Characterization of Materials for Photoelectrochemical Hydrogen Production
Hydrogen and Fuel Cells Program ARRA
H2RA006; Darin Painter, ReliOn Inc.: PEM Fuel Cell Systems Providing Backup Power to Commercial Cellular Towers and an Electric Utility Communications
H2RA004; Jim Fletcher, U of North Florida: Advanced Direct Methanol Fuel Cell for Mobile Computing
Manufacturing R&D
MN011; Eric Stanfield, NIST: Cause and Effect: Flow Field Plate Manufacturing Variability and its Impact on Performance

Thursday, May 17 - Oral Presentations

Hotel	Crystal Gateway	Crystal Gateway	Crystal Gateway
Salon	I	II	III
8:15 AM		PD00A; Scott Weil, DOE: Hydrogen Delivery Session Introduction	
8:30 AM	LM008; Alan Luo, USAMP/AMD: Magnesium Front End Development (AMD 603/604/904)	PD014; Amgad Elgowainy, ANL: Hydrogen Delivery Infrastructure Analysis	ES162; Robert Tenent, NREL: Development of Industrially Viable Battery Electrode Coatings
9:00 AM	LM012; Mei Li, USAMP/AMD: Integrated Computational Materials Engineering (ICME) for Mg: International Pilot Project	PD017; Frank Di Bella, Concepts NREC: Development of a Centrifugal Hydrogen Pipeline Gas Compressor	ES164; David Wood, ORNL: Overcoming Processing Cost Barriers of High-Performance Lithium-Ion Battery Electrodes
9:30 AM	LM055; Jake Zindel, USAMP/AMD: Ablation Casting Evaluation for High Volume Structural Castings	PD016; Hooshang Heshmat, Mohawk Innovative Technology: Oil-Free Centrifugal Hydrogen Compression Technology Demonstration	ES030; Andrew Jansen, ANL : Fabricate PHEV Cells for Testing & Diagnostics
10:00 AM	LM035; Steve Derezinski, MOxST: Scale-Up of Magnesium Production by Fully Stabilized Zirconia Electrolysis	PD048; Ludwig Lipp, FuelCell Energy, Inc.: Electrochemical Hydrogen Compressor	ES165; David Wood, ORNL: Roll-to-Roll Electrode Processing and Materials NDE for Advanced Lithium Secondary Batteries
10:30 AM	BREAK	BREAK	BREAK
11:00 AM	LM056; Curt Lavender, PNNL: Non-Rare Earth High-Performance Wrought Magnesium Alloys	PD024; Barton Smith, ORNL: Composite Pipeline Technology for Hydrogen Delivery	ES036; Chris Orendorff, SNL: Abuse Tolerance Improvements
11:30 AM	LM057; Xin Sun, PNNL: PNNL: Mechanistic-Based Ductility Prediction for Complex Mg Castings	PD021; Norm Newhouse, Lincoln Composites: Development of High Pressure Hydrogen Storage Tank for Storage and Gaseous Truck Delivery	ES166; Ira Bloom, ANL: Post-test Cell Characterization Facility
12:00 PM	LM058; Govindarajan Muralidharan , ORNL: Low-Cost Magnesium Sheet Production using the Twin Roll Casting Process and Asymmetric Rolling	PD088; Wei Zhang, ORNL: Vessel Design and Fabrication Technology for Stationary High-Pressure Hydrogen Storage	ES167; Greg Krumdick, ANL: Process Development and Scale-up of Advanced Cathode Materials
12:30 PM	LUNCH 1:15 PM - Presentation by Mark Johnson from ARPA-E		
1:45 PM	LM036; Nagraj Kulkarni, ORNL: Diffusion Databases for Mg-ICME	PD022; Thad Adams, SRNL: Fiber Reinforced Composite Pipelines	ES168; Chris Pupek, ANL: Process Development and Scale up of Advanced Electrolyte Materials
2:15 PM	LM037; Paul Wang, Mississippi St Univ: Southern Regional Center for Lightweight Innovative Design (SRCLID)	PD025; Brian Somerday, SNL: Hydrogen Embrittlement of Structural Steels	ES035; Zonghai Chen, ANL: Develop and Evaluate Materials and Additives that Enhance Thermal and Overcharge Abuse
2:45 PM	LM068; Ba Nguyen, PNNL: Engineering Property Prediction Tools for Tailored Polymer Composite Structures	PD070; Mike Roberts, Gas Technology Inst.: One Step Biomass Gas Reforming-Shift Separation Membrane Reactor	ES037; Guoying Chen, LBNL: Overcharge Protection for PHEV Batteries
3:15 PM	LM060; Mark Smith, PNNL: Aerodynamic Lightweight Cab Structure Components	PD072; Paul Liu, Media and Process Technology Inc.: Development of Hydrogen Selective Membranes/Modules as Reactors/Separators for Distributed Hydrogen Production	ES027; Kevin Gering, INL: Novel Phosphazene Compounds for Enhancing Electrolyte Stability and Safety of Lithium-ion Cells
3:45 PM	BREAK	BREAK	BREAK
4:15 PM	LM061; Nia Harrison, USAMP/AMD: Optimization of High-Volume Warm Forming for Lightweight Sheet Alloys	PD002; David King, PNNL: Biomass-Derived Liquids Distributed (Aqueous Phase) Reforming	ES113; Zhengcheng Zhang, ANL: High Voltage Electrolyte for Lithium Batteries
4:45 PM	LM033; Rich Davies, PNNL: Pulse-Pressure Forming of Lightweight Metals	PD004; Stefan Czernik, NREL: Distributed Bio-Oil Reforming	ES024; Richard Jow, Army Research Laboratory: High Voltage Electrolytes for Li-ion Batteries
5:15 PM	LM062; Zhili Feng, ORNL: Improving Fatigue Performance of AHSS Welds		ES025; Zhengcheng Zhang, ANL: Advanced Electrolyte Additives for PHEV/EV Lithium-ion Battery
5:45 PM			ES026; Marshall Smart, JPL: Electrolytes for Use in High Energy Lithium-Ion Batteries with Wide Operating Temperature Range

Thursday, May 17 - Oral Presentations

Hotel Salon	Crystal Gateway IV	Crystal Gateway V	Crystal Gateway VI
8:15 AM			
8:30 AM	FC017; Rajesh Ahluwalia, ANL: Fuel Cells Systems Analysis	ST028; Christopher Wolverton, Northwestern U: Design of Novel Multi-Component Metal Hydride-Based Mixtures for Hydrogen Storage	VSS018; Greg Cesiel, General Motors : Plug-in Hybrid (PHEV) Vehicle Technology Advancement and Demonstration Activity
9:00 AM	FC018; Brian James, Strategic Analysis, Inc.: Fuel Cell Transportation Cost Analysis, Preliminary Results	ST031; Craig Jensen, U of Hawaii: Advanced, High-Capacity Reversible Metal Hydrides	VSS063; Abdullah Bazzi, Chrysler LLC: Advancing Plug In Hybrid Technology and Flex Fuel Application on a Chrysler Mini-Van PHEV DOE Funded Project
9:30 AM	FC097; Kathya Mahadevan, Battelle: Stationary and Emerging Market Fuel Cell System Cost Analysis	ST048; Andrew Goudy, Delaware State U: Hydrogen Storage Materials for Fuel Cell Powered Vehicles	VSS081; Pascal Amar, Volvo Trucks: Development and Demonstration of a Fuel-Efficient Class 8 Highway Vehicle
10:00 AM	FC098; Max Wei, LBNL: A Total Cost of Ownership Model for Design and Manufacturing Optimization of Fuel Cells in Stationary and Emerging Market Applications		VSS064; Dennis Jadin, Navistar: SuperTruck – Development and Demonstration of a Fuel-Efficient Class 8 Tractor & Trailer
10:30 AM	BREAK	BREAK	BREAK
11:00 AM	FC020; Karren More, ORNL: Characterization of Fuel Cell Materials	ST038; Shih-Yuan Liu, U of Oregon: Hydrogen Storage by Novel CBN Heterocycle Materials	ARRAVT080; Derek Rotz, DTNA: Class 8 Truck Freight Efficiency Improvement Project
11:30 AM	FC021; David Jacobson, NIST: Neutron Imaging Study of the Water Transport in Operating Fuel Cells	ST040; Benjamin Davis, LANL: Fluid Phase H2 Storage Material Development	ARRAVT081; Scott Newhouse, Peterbilt: Technology and System Level Demonstration of Highly Efficient and Clean, Diesel Powered Class 8 Trucks
12:00 PM	FC081; Jennifer Kurtz, NREL: Fuel Cell Technology Status - Voltage Degradation	ST098; Craig Jensen, Hawaii Hydrogen Carriers, LLC: Development of a Practical Hydrogen Storage System based on Liquid Organic Hydrogen Carriers and a Homogeneous Catalyst	ARRAVT070; Jon Gustafson, Cascade Sierra Solutions: Interstate Grid Electrification Improvement Project
12:30 PM	LUNCH 1:15 PM - Presentation by Mark Johnson from ARPA-E		
1:45 PM	FC092; Jon Owejan, GM: Investigation of Micro- and Macro-Scale Transport Processes for Improved Fuel Cell Performance	ST099; Felix Paulauskas, ORNL: Development of Low-Cost, High Strength Commercial Textile Precursor (PAN-MA)	ARRAVT066; Don Karner, Electric Transportation Engineering Corp.: Electric Drive Vehicle Demonstration and Vehicle Infrastructure Evaluation
2:15 PM	FC026; Adam Weber, LBNL: Fuel-Cell Fundamentals at Low and Subzero Temperatures	ST093; Felix Paulauskas, ORNL: Melt Processable PAN Precursor for High Strength, Low-Cost Carbon Fibers	ARRAVT073; Kumar Gogineni, Coulomb: ChargePoint America
2:45 PM	FC028; Robert Dross, Nuvera Fuel Cells: Transport Studies Enabling Efficiency Optimization of Cost-Competitive Fuel Cell Stacks	MN008; Mark Leavitt, Quantum Fuel Systems Technologies Worldwide, Inc.: Development of Advanced Manufacturing Technologies for Low Cost Hydrogen Storage Vessels	ARRAVT071; Greg Cesiel, General Motors : Advanced Vehicle Electrification and Transportation Sector Electrification
3:15 PM	FC054; Cortney Mittelsteadt, Giner Electrochemical Systems, LLC: Transport in PEMFC Stacks	ST053; Barton Smith, ORNL: Lifecycle Verification of Polymer Liners in Storage Tanks	ARRAVT072; Robin Mackie, Smith Electric Vehicles: Smith Electric Vehicles: Advanced Vehicle Electrification + Transportation Sector
3:45 PM	BREAK	BREAK	BREAK
4:15 PM	FC067; Will Johnson, W.L. Gore: Materials and Modules for Low-Cost, High Performance Fuel Cell Humidifiers		ARRAVT067; Abdullah Bazzi, Chrysler LLC: Advancing Transportation Through Vehicle Electrification - PHEV
4:45 PM	FC083; Chris Ainscough, NREL: Enlarging Potential National Penetration for Stationary Fuel Cells Through System Design Optimization		ARRAVT069; Dion Van Leeve, Navistar, Inc.: Advanced Vehicle Electrification
5:15 PM	FC077; Satish Mohapatra, Dynalene: Fuel Cell Coolant Optimization and Scale-up (plus work under SBIR III project)		VSS019; Julie D'Annunzio, Ford: Ford Plug-In Project: Bringing PHEVs to Market
5:45 PM			VSS093; Jim McCabe, ANSI: ANSI Electric Vehicle Standards Roadmap

Thursday, May 17 - Oral Presentations

Hotel	Crystal City	Crystal City	Crystal City
Salon	D	E	F
8:15 AM			ED000; Gregory Kleen, DOE: Education and Outreach Session Introduction
8:30 AM	ARRAVT048; Maria Redmond, State of Wisconsin: Wisconsin Clean Transportation Program	ACE030; Puxian Gao, U of Connecticut: Three-Dimensional Composite Nanostructures for Lean NOx Emission Control	ED010; Shannon Baxter-Clemmons, South Carolina Hydrogen and Fuel Cell Alliance: Development of Hydrogen Education Programs
9:00 AM	ARRAVT050; Patrick Flynn, State of Indiana: State of Indiana/Greater IN Clean Cities Alternative Fuels Implementation Plan	ACE077; Bill Partridge, ORNL: CRADA with Cummins on Characterization and Reduction of Combustion Variations	ED013; Pat Valente, Ohio Fuel Cell Coalition: Raising H2 and Fuel Cell Awareness in Ohio
9:30 AM	ARRAVT051; Chuck Feinberg, New Jersey Clean Cities Coalition: NJ Compressed Natural Gas Refuse Trucks, Shuttle Buses and Infrastructure	ACE032; Bill Partridge, ORNL: Cummins/ORNL-FEERC CRADA: NOx Control & Measurement Technology for Heavy-Duty Diesel Engines	ED012; Joel Rinebold, Connecticut Center for Advanced Technology, Inc.: State and Local Government Partnership
10:00 AM	ARRAVT054; Cynthia Maves, Clean Fuels Ohio: The Ohio Advanced Transportation Partnership (OATP)	ACE033; Todd Toops, ORNL: Emissions Control for Lean Gasoline Engines	ED014; Patrick Serfass, Technology Transition Corporation: H2L3: Hydrogen Learning for Local Leaders
10:30 AM	BREAK	BREAK	BREAK
11:00 AM	ARRAVT055; Sean Reed, Clean Energy Coalition : RECOVERY ACT -- CLEAN ENERGY COALITION MICHIGAN GREEN FLEETS	ACE078; George Muntean, PNNL: Investigation of Mixed Oxide Catalysts for NO Oxidation	ED017; Mary Spruill, NEED: H2 Educate! Hydrogen Education for Middle Schools
11:30 AM	ARRAVT061; Samantha Bingham, City of Chicago, Department of Environment: Chicago Area Alternative Fuels Deployment Project (CAAFDP)	ACE055; Chuck Peden, PNNL: Deactivation Mechanisms of Base Metal/Zeolite Urea Selective Catalytic Reduction Materials, and Development of Zeolite-Based Hydrocarbon Adsorber Materials	
12:00 PM	ARRAVT063; Christopher Rice, Maryland Energy Administration: Maryland Hybrid Truck Goods Movement Initiative	ACE056; Mark Stewart, PNNL: Fuel-Neutral Studies of Particulate Matter Transport Emissions	
12:30 PM	LUNCH - Lunch speaker will be in the Crystal Gateway Hotel		
1:30 PM			TV000; Jason Marcinkoski, DOE: Technology Validation Session Introduction
1:45 PM	ARRAVT041; Beth Baird, Idaho Petroleum Reduction Leadership Project: Idaho Petroleum Reduction Leadership Project	ACE079; Rangachary Mukundan, LANL: Robust Nitrogen Oxide/Ammonia Sensors for Vehicle On-board Emissions Control	TV001; Keith Wipke, NREL: Controlled Hydrogen Fleet and Infrastructure Analysis
2:15 PM	ARRAVT042; Stephanie Meyn, Puget Sound Clean Air Agency: Puget Sound Clean Cities Petroleum Reduction Project	ACE044; Dan Greenbaum, Health Effects Institute: Advanced Collaborative Emissions Study (ACES)	TV008; Leslie Eudy, NREL: Technology Validation: Fuel Cell Bus Evaluations
2:45 PM	ARRAVT043; Robin Erickson, Utah Clean Cities Coalition: Utah Clean Cities Transportation Sector Petroleum Reduction Technologies Program		TV006; Ed Heydorn, Air Products: Validation of an Integrated Hydrogen Energy Station
3:15 PM	ARRAVT056; Kelly Gilbert, Metropolitan Energy Information Center: Midwest Region Alternative Fuels Project		TV007; Ed Heydorn, Air Products: California Hydrogen Infrastructure Project
3:45 PM	BREAK	BREAK	BREAK
4:00 PM		ACE00C; Roland Gravel, DOE: Overview of the DOE High Efficiency Engine Technologies R&D	
4:15 PM	ARRAVT049; Lee Grannis, Connecticut Clean Cities Future Fuels Project: Connecticut Clean Cities Future Fuels Project	ACE060; Pascal Amar, Volvo: Volvo SuperTruck - Powertrain Technologies for Efficiency Improvement	TV015; Kevin Harrison, NREL: Renewable Electrolysis Integrated System Development & Testing
4:45 PM	ARRAVT052; Rita Ebert, Greater Long Island Clean Cities Coalition: Promoting a Green Economy through Clean Transportation Alternatives	ACE057; David Koeberlein, Cummins: Cummins SuperTruck Program - Technology and System Level Demonstration of Highly Efficient and Clean, Diesel Powered Class 8 Trucks	
5:15 PM	ARRAVT053; Adam Ruder, New York State Energy Research and Development Authority: New York State-wide Alternative Fuel Vehicle Program for Vehicles and Fueling Stations	ACE058; Kevin Sisken, Detroit Diesel: Supertruck - Improving Transportation Efficiency through Integrated Vehicle, Engine and Powertrain Research	
5:45 PM		ACE059; Dennis Jadin, Navistar International Corp.: Supertruck - Development and Demonstration of a Fuel-Efficient Class 8 Tractor & Trailer	

Thursday, May 17 - Poster Presentations
Crystal Gateway Hotel - SkyView, 6:30-8:30 PM

Technology Validation
TV016; Jennifer Kurtz, NREL: Stationary Fuel Cell Evaluation
TV017; Sam Sprik, NREL: Next Generation H2 Station Analysis
TV009; Mitch Ewan, Hawaii Natural Energy Inst.: Hawaii Hydrogen Power Park
TV012; David Block, U of Central Florida: Florida Hydrogen Initiative (FHI)
TV014; David Blehman, Cal State LA U Aux. Services, Inc.: Sustainable Hydrogen Fueling Station, California State University, Los Angeles
Solid-State Energy Conversion
ACE069; Yongho Ju, UCLA: Integration of Advanced Materials and Interfaces for Durable Thermoelectric Automobile Exhaust Waste Heat Harvesting Devices
ACE070; Ali Shakouri, UC Santa Cruz: Mg ₂ Si Composites with Embedded Si Nanoparticles for Energy Recovery of Waste Exhaust Heat
ACE071; Sreeram Vaddiraju, Texas A&M Univ. : NSF/DOE Thermoelectric Partnership: Inorganic-Organic Hybrid Thermoelectrics
ACE072; Scott Huxtable, VPI & SU: An integrated approach towards efficient, scalable, and low cost thermoelectric waste heat recovery devices for vehicles
ACE073; Chad Baker, Univ of Texas, Austin: NSF/DOE Thermoelectric Partnership: High-Performance Thermoelectric Devices Based on Abundant Silicide Materials for Vehicle Waste Heat Recovery
ACE074; Xianfan Xu, Purdue Univ: Thermoelectrics for Automotive Waste Heat Recovery
Advanced Combustion
ACE083; Kyeong Lee, ANL: Detailed Assessment of Particulate Characteristics from Low-Temperature Combustion Engines

GRAND BALLROOM

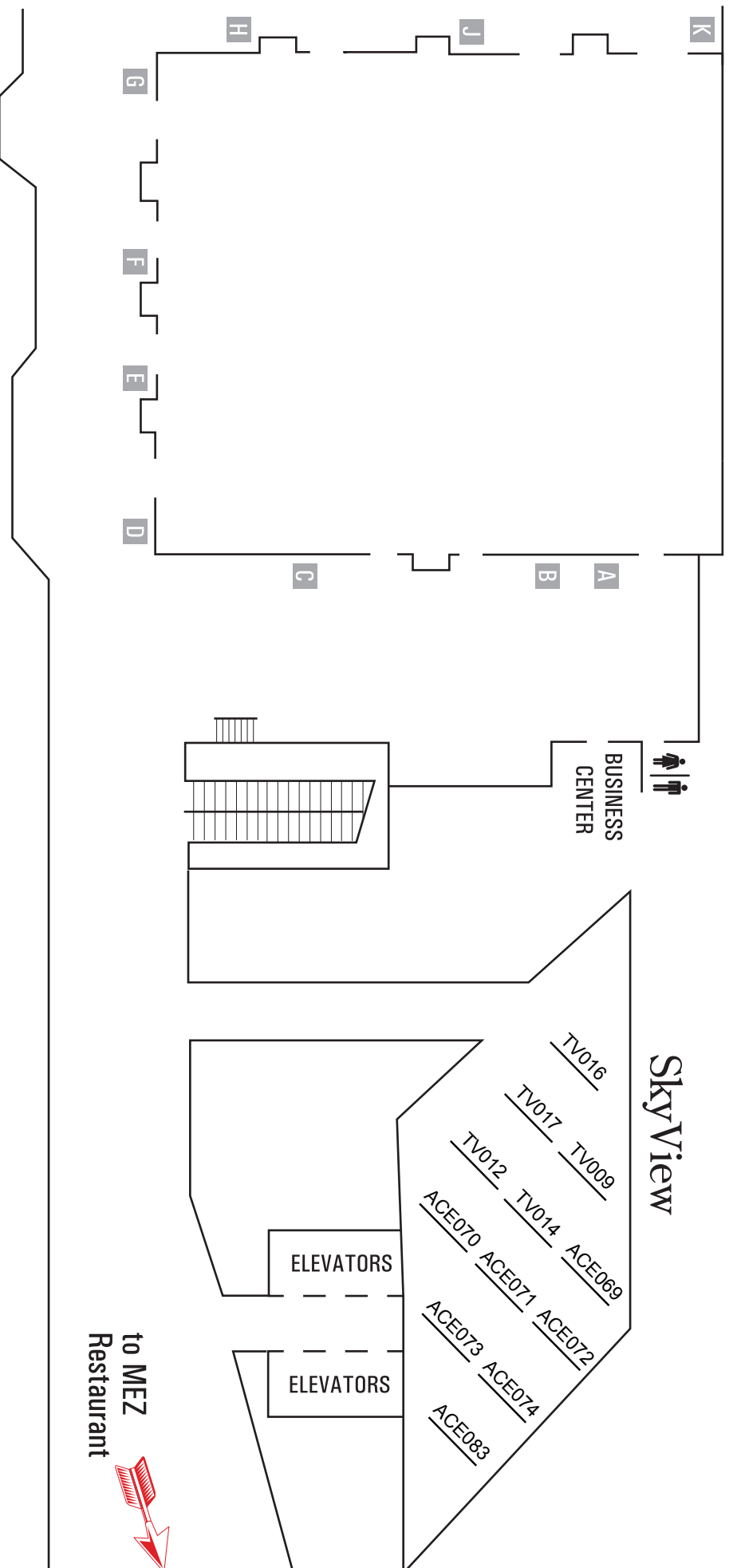

POSTER MAP

Thursday, May 17

Crystal Gateway Marriott



2012 DOE ANNUAL MERIT REVIEW AND PEER EVALUATION MEETING

Friday, May 18 - Oral Presentations

Hotel Salon	Crystal Gateway I	Crystal Gateway II	Crystal Gateway III
8:15 AM			
8:30 AM	LM063; Gene Hsiung, USAMP/ASP: Advanced High-Strength Steel Stamping		
9:00 AM	LM064; Thomas Stoughton, USAMP/ASP: Nonlinear Strain Paths		
9:30 AM	LM065; Raj Sohmshtetty, USAMP/ASP: Mapping of Forming Effects to Structural Models		
10:00 AM	LM066; Phil Yaccarino, USAMP/ASP: Lightweight Sealed Steel Fuel Tanks for Advanced Hybrid Electric Vehicles		
10:30 AM	BREAK	BREAK	BREAK
11:00 AM	LM067; Xin Sun, PNNL: First Generation Advanced High-Strength Steels Deformation Fundamentals		
11:30 AM	LM030; Yuri Hovanski, PNNL: Friction Stir and Ultrasonic Solid State Joining of Magnesium to Steel		
12:00 PM	LM028; Edgar Lara-Curzio, ORNL/HTML: Materials Characterization Capabilities at the High Temperature Materials Laboratory and HTML User Program Success Stories		

Hotel Salon	Crystal Gateway IV	Crystal Gateway V	Crystal Gateway VI
8:15 AM			VSS082; Yury Kalish, DOE: Overview of VMT Reduction and Legacy Fleet Improvement
8:30 AM	FC035; James Fenton, U of Central Florida: Lead Research and Development Activity for DOE's High Temperature, Low Relative Humidity Membrane Program		VSS083; Jay Kim, Cooper Tire: Improving Vehicle Fuel Efficiency Through Tire Design, Materials, and Reduced Weight
9:00 AM	FC038; Peter Pintauro, Vanderbilt U: NanoCapillary Network Proton Conducting Membranes for High Temperature Hydrogen/Air Fuel Cells		VSS084; Timothy Okel, PPG: A Materials Approach to Fuel-Efficient Tires
9:30 AM	FC039; Andrew Herring, Colorado School of Mines: Novel Approaches to Immobilized Heteropoly Acid (HPA) Systems for High Temperature, Low Relative Humidity Polymer-Type Membranes		VSS085; Robert Benedict, Goodyear: System for Automatically Maintaining Pressure in a Commercial Truck Tire
10:00 AM	FC040; Ludwig Lipp, FuelCell Energy, Inc.: High Temperature Membrane with Humidification-Independent Cluster Structure		VSS086; Matthew Barth, University of California at Riverside: Next Generation Environmentally Friendly Driving Feedback Systems Research and Development
10:30 AM	BREAK	BREAK	BREAK
11:00 AM	FC036; Cortney Mittelsteadt, Giner Electrochemical Systems, LLC: Dimensionally Stable High Performance Membranes		VSS087; Zwick Tang, Eaton: Look-ahead Driver Feedback and Powertrain Management
11:30 AM	FC090; Stephen Grot, Ion Power: Corrugated Membrane Fuel Cell Structures		
12:00 PM			

Friday, May 18 - Oral Presentations

Hotel	Crystal City	Crystal City	Crystal City
Salon	D	E	F
8:15 AM			ACE00E; John Fairbanks, DOE: Automotive Thermoelectric Generators and HVAC
8:30 AM	ARRAVT057; Lori Clark, North Central Texas Council of Governments: North Central Texas Alternative Fuel and Advanced Technology Investments	ACE061; Michael Ruth, Cummins: ATP-LD; Cummins Next Generation Tier 2 Bin 2 Diesel Engine	ACE047; Clay Maranville, Ford Motor Company: Thermoelectric HVAC and Thermal Comfort Enablers for Light-Duty Vehicle Applications
9:00 AM	ARRAVT058; Heather Ball, Railroad Commission of Texas: Texas Propane Vehicle Pilot Project	ACE037; Harold Sun, Ford Motor Company: Advanced Boost System Development for Diesel HCCI/LTC Application	ACE048; Jeffrey Bozeman, General Motors: Energy Efficient HVAC System for Distributed Cooling/Heating with Thermoelectric Devices
9:30 AM	ARRAVT059; Todd Ewing, Texas State Technical College: Development of National Liquid Propane (Autogas) Refueling Network, Clean School Bus/Vehicle Incentive & Green Jobs Outreach Program	ACE062; Ron Reese, Chrysler: A MultiAir / MultiFuel Approach to Enhancing Engine System Efficiency	ACE080; Vladimir Jovovic, Amerigon: Thermoelectric Waste Heat Recovery Program for Passenger Vehicles
10:00 AM		ACE063; Halim Santoso, General Motors: Lean Gasoline System Development for Fuel Efficient Small Car	ACE081; Greg Meisner, General Motors: Development of Cost-Competitive Advanced Thermoelectric Generators for Direct Conversion of Vehicle Waste Heat into Useful Electrical Power
10:30 AM	BREAK	BREAK	BREAK
11:00 AM		ACE064; Keith Confer, Delphi Automotive Systems: Gasoline Ultra Fuel Efficient Vehicle	ACE082; Chris Caylor, GMZ Energy Inc.: Nanostructured High-Temperature Bulk Thermoelectric Energy Conversion for Efficient Automotive Waste Heat Recovery
11:30 AM		ACE065; Corey Weaver, Ford Motor Company: Advanced Gasoline Turbocharged Direct Injection (GTDI) Engine Development	ACE067; Kenneth Goodson, Stanford Univ: Thermoelectrics Partnership: Automotive Thermoelectric Modules with Scalable Thermo- and Electro-Mechanical Interfaces
12:00 PM		ACE066; Hakan Yilmaz, Robert Bosch: Advanced Combustion Concepts - Enabling Systems and Solutions (ACCESS) for High Efficiency Light Duty Vehicles	ACE068; Joseph Heremans, Ohio State Univ: DOE/NSF Thermoelectric Partnership Project SEEBECK Saving Energy Effectively By Engaging in Collaborative Research and Sharing Knowledge